

**BONTRAGER
OUTDOORS
2026 OWNER'S
MANUAL**

**COMPACT &
STANDARD
SERIES**

BONTRAGER OUTDOORS RV

We thank you and congratulate you on your purchase of a Bontrager Outdoors RV. You have chosen a quality-built product that will provide you with many years of camping memories and family traditions.

Your product has been inspected by our trained inspectors and meets our high-quality standards. We are proudly RVIA and CSA certified.

Your dealer will assist you with any questions.

**Bontrager Outdoors RV, LLC
0925N State Road 5
Shipshewana, IN 46565
260-768-7932**



The terms **NOTE**, **CAUTION**, **WARNING** and **DANGER** have specific meanings in this manual as well as component manuals.

A **NOTE** provides additional information to make a step or procedure easier or clearer. Disregarding a **NOTE** could cause inconvenience but would not be likely to cause damage or personal injury.

A **CAUTION** emphasizes areas where equipment damage could result. Disregarding a **CAUTION** could cause permanent mechanical damage. However, personal injury is unlikely.

A **WARNING** is giving notice to users that potential injuries may occur to a person from equipment and mechanical failure. Disregarding a **WARNING** may result in serious physical injury to the occupant.

A **DANGER** alerts areas where safety measures **MUST** be strictly adhered to, as such failures can be dangerous. Disregarding a **DANGER** could cause serious injury and possible loss of life.

Reporting Safety Defects

If you believe that your vehicle has a defect which could cause a crash or could cause injury or death, you should immediately inform the National Highway Traffic Safety Administration (NHTSA) for U.S. customers or Transport Canada for Canadian customers in addition to notifying Bontrager Outdoors RV.

If NHTSA or Transport Canada in addition receives similar complaints, it may open an investigation, and if it finds that a safety defect exists in a group of vehicles, it may order a recall and remedy campaign. However, NHTSA or Transport Canada cannot become involved in individual problems between you, your dealer, or Bontrager Outdoors RV.

Contact information for NHTSA or Transport Canada below:

NHTSA
US Department of Transportation
Washington, DC 20590
Phone: 800-424-9393

Transport Canada
Ottawa, ON K1A 0N5
Phone: 613-993-6161

Table of Contents

Safety	5	Refrigerator	73
Weight Ratings.....	6	Monitor Panel	75
Cold Weather Use & Condensation... 7		Camper Maintenance & Care	76
Service Procedures & Warranty	9	Frame, Coupler, Jacks	76
Using & Hooking Up Camper	11	Tires	77
Traveling Weight & Loading Info.....	15	Lugs.....	78
Tire Information	20	Bearings	80
Brakes	26	Brakes	82
Breakaway Switch.....	27	Exterior	84
Campsite Setup	28	Extrusions & Vents.....	85
Safety Products Detectors	29	Sealant Suggestions	86
Components on Camper.....	34	Systems	86
Plumbing	36	Optional Awning.....	88
Bath & Shower	39	Maintenance Schedule.....	90
Water Lines.....	40		
Sanitizing.....	41		
Winterizing Your Camper.....	45		
Propane Fuel System	48		
Electrical System	58		
120-volt A/C System.....	60		
Circuit Brakers & Fuses	63		
7-Way Connector Plug.....	64		
Solar Panel Control Panel.....	65		
Appliances	66		
Truma Combi.....	67		
Stove	70		

Safety When Emergency Stopping

It is wise to carry road flags and/or triangular warning devices to be used when necessary. When pulling off a highway, use your four-way hazard lights as warning flashers, even if only to change drivers. Pull off the roadway completely if at all possible, to change flat tires or any other emergency.

Safety Considerations

1. Sanitize the freshwater supply system periodically.
2. Keep water connection fittings and drain hoses from coming in contact with the ground to reduce the chance of contamination.
3. Enlist the services of a qualified RV technician to fix gas or electrical appliances.
4. Always have a serviceable fire extinguisher placed in an easily accessible location.
5. Ensure that the tires are in good condition and properly inflated, check the Federal Identification label on the driver side front corner for tire inflation information. Improperly inflated tires are a potential hazard. Check the tire pressure before each trip when the tires are cold.
6. Check and tighten the wheel lugs regularly. For new campers check and tighten the wheel lugs every 50 miles until 200 miles are reached and then check the lugs every 500 miles. See pages 81-82 for more information.
7. Check the brakes in a safe area – not while traveling on a busy highway.
8. Always block the trailer wheels securely before unhitching.
9. Before leaving a camp area with a trailer in tow, ensure the following items are done:
 - a. The safety pin or locking lever is seated.
 - b. The breakaway wire is attached to the tow vehicle.
 - c. All jacks are raised so they cannot touch the ground.
 - d. The 110-volt electrical cord is properly stored.
 - e. The safety chains are properly connected to the tow vehicle.
 - f. All interior lights are turned off.
10. Observe and obey the warning labels attached to your vehicle concerning propane, water, electricity, and loading.
11. Extinguish all campfires before leaving your campsite.

Weight Ratings

Below are the weight ratings for the roof rack (if applicable), top and bottom bunk (if applicable).

- Roof rack: 500 lbs.
- Top bunk: 200 lbs.
- Bottom bunk: 250 lbs.
- Rear accessory hitch (if applicable): 150 lbs.
- Optional Gear Net for 10LTX & 12LTX, 12RAD, 12ROK: 25 lbs.
- Optional Gear Net for 15 & 17 Models: 45 lbs.

Cold Weather Use and Condensation

Your Bontrager Outdoors RV camper has been built for enjoyment in a recreational manner. This camper is not intended to be used as full-time living quarters, nor is this camper a four-season unit.

Using this unit in freezing conditions is not recommended. However, if unit is used in freezing weather, the following are guidelines to follow. Any problems resulting from freezing **are not covered** under warranty.

1. For winter use in freezing conditions, more protection may be required. Use skirting and/or insulation below floor level to provide additional protection.
2. Remember, water freezes at 32° Fahrenheit (0° Celsius) whether fresh or drainage. Proper care must be used to protect any system at 32°F/0°C or lower. Local recreational vehicle dealers and campground personnel may be able to advise you on needed protection.
3. Energy requirements, such as propane and electrical supplies must be adequate. Protect your propane regulator from freeze ups.
4. During cold weather, you will experience more condensation than normal. Using ventilation or a dehumidifier may be necessary.

Condensation

Where it comes from, what causes it, and various solutions. Condensation is not a warranty issue.

Causes:

1. It occurs when warm moist air contacts a cold surface, such as rain touching the tent fabric with people breathing warm moist air against it from inside due to normal breathing.
2. When cooking food or taking a shower, warm moist air circulates throughout the camper attaching itself to cooler surfaces, forming beads and running down a wall or window.
3. Normal breathing will emit approximately 1/2 pint of moisture into the air per person, per day. The more occupants, the greater quantity of condensation you may find.

Solutions:

1. When taking a shower, open bath roof vent approximately $\frac{1}{2}$ inch, allowing moisture to escape.
2. Use the power vent over the range when cooking.
3. If condensation is found in cabinet or closets, open door slightly to equalize temperature and provide ventilation.
4. Opening windows and roof vents, when possible, allowing warm moist air to escape is the best way to reduce condensation.
5. Under extreme conditions, you may need to use a dehumidifier to remove moisture from the air.

Uncontrolled condensation can cause dampness, mildew, etc., inside your recreational vehicle. Be sure to make strong efforts to control condensation.

Interior Ventilation

A new camper always has a peculiar aroma in it due to all the components used to build it, such as plywood, paneling, carpet and fabrics.

Allowing fresh air to move and circulate through out a new camper is very valuable as components used have chemicals in them that may cause possible irritation to the respiratory system of the human body.

There are numerous ways to provide air exchange in campers:

1. Open windows on non-rainy days, allowing air exchange between inside and outside.
2. Power hood vent above cooking stove will send heat and food smell outside.
3. Roof vent-numerous types:
 - a. Standard air flow using gravity flow method.
 - b. Power (12v or 110v) vents will move air faster.
 - c. Hi-volume power vents, operation in 12-volt power can exchange air in a camper in several minutes if windows are open accordingly. If there is a fan in the rear, open window(s) in front.

Carefully read the operating instructions, which are provided by the manufacturer, and can be found in your camper.

Service Procedures and Warranty

Bontrager Outdoors RV and your Bontrager Outdoors RV dealer have a strong and dedicated interest in maintaining the highest quality customer relations with its owners.

Your satisfaction with your Bontrager Outdoors camper and your Bontrager Outdoors RV dealer is our primary concern. In addition to producing high quality products, we want to assure our customers that support with parts and service is available. **Our dealer network is the first line of communication to serve and supply your needs for your camper.** Our authorized dealers will assist in providing service maintenance needs, including part options and information concerning your camper. Should you experience a problem with service availability, please follow the steps in the order listed below:

1. Contact your selling dealer's service department for an appointment. Describe to the best of your knowledge the nature of the problem. Please keep appointments to establish a good, workable relationship.
2. Contact the owner or general manager of the dealership, should the initial attempt fail with the dealer service department: contact: Bontrager Outdoors Customer Service Department:

Bontrager Outdoors RV
925 N. State Road 5
Shipshewana, IN 46565
Phone: (260) 768-7932
Hours: (8:00 am - 4:30 pm E.S.T.)
E-mail: warranty@bontrageroutdoors.com
Website: [www. Bontrager Outdoors.com](http://www.BontragerOutdoors.com)

Please provide Bontrager Outdoors Customer Service with information regarding the issue you are experiencing with your camper along with the serial number of the camper in question. We will make every attempt to resolve your problem. Please bear in mind that most problems arise from

any misunderstandings concerning warranty coverage and service. In most instances, you will be referred to the dealer level and your concerns will be resolved with the dealer's facilities and personnel.

Dealer

Your authorized Bontrager Outdoors RV dealer has performed a PDI (pre-delivery inspection) on your camper. Your dealer is authorized to sell Bontrager Outdoors RV products, they are also there to supply parts, optional equipment, and provide service repairs, warranty or otherwise as needed.

The first point of contact for warranty repairs will be your Bontrager Outdoors RV dealer. Other dealers can be used; however, prior approval is required.

Some recreational vehicle dealers may be authorized service centers for certain manufacturers of products warranted separately, such as appliances. Check with your dealer before contacting anyone else to reduce delays. If the dealer is not an authorized service center for the product in question, they can assist you in obtaining authorized service.

Parts

Stocking of parts varies from dealer to dealer. Any authorized dealer can order required parts to be shipped to their dealership. All parts are obtained through an authorized Bontrager Outdoors RV dealer only.

Owner's Responsibility

When owning and using a camper, it is important to perform regular and normal maintenance. This is recommended twice a year, spring, and fall, to prevent undesired deterioration of your camper. Weather elements play an important function on sealants and other components, requiring normal maintenance.

As an owner of the camper, it is your responsibility and obligation to inspect and return your camper to an authorized dealer for repairs as required. Your authorized selling dealer is always your first point of contact. As your manufacturer, we recommend that inspection and service be performed by your selling dealership.

If you are traveling and are unable to locate an authorized Bontrager Outdoors RV dealer, or an authorized dealer for the component needing service, please call our Customer Service Department at 260-768-7932. Service at a non-authorized dealer **MUST** have prior authorization from the manufacturer. You may be asked to return mechanical parts before reimbursement consideration is made. Unauthorized or improper repairs may void the warranty of that component.

Warranty coverage *does not* include trip or service call fees. It is the owner's responsibility to provide for such costs.



Seasonal Site

When placing your unit on a camp site in the spring and returning it in the fall to your home/place of storage, it's classed as a "seasonal site."

Performing repair work on such a site is not recommended for numerous reasons: available parts, tools, space, weather conditions, etc.

Any service repairs which require a service technician also require the unit to be taken to a service facility, preferably your selling dealer.

Using and Hooking up Your Camper

In this section you will find three areas of useful information to assist you with correct equipment, traveling, and using your camper.

Tow Vehicle

Begin your camping experiences by obtaining a tow vehicle that can adequately transport your camper. Your most important measuring tool is the GVWR (Gross Vehicle Weight Rating) to cross match the capability of your selected tow vehicle.

Most auto and truck manufactures provide trailer towing guides for their products. Ask your local automotive dealer for a copy or call the factory's direct lines for information. Many tow vehicles, including mini vans, have special towing package options available for small campers. Tow vehicles with long wheelbases perform better than those with short wheelbases.

Understanding the GCWR (Gross Combined Weight Rating) is also important. GCWR refers to the total weight (or combined weight) of the tow vehicle and what it is towing. This information, supplied by the tow vehicle manufacturer, is related to the capability of the tow vehicle. The condition of the suspension in your tow vehicle is also an important factor. Ensure your tow vehicle is in good operating condition and follow the factory recommended maintenance guidelines.

Hitches

After obtaining your tow vehicle, it is very important to have the correct hitch system. Weight distributing bars may be necessary to accommodate your camper. This selection and installation should be done by a professional hitch service center, which may or may not be your selling dealer. Sway controls may be needed based on size and weight of camper, plus capability of your tow vehicle.

Weight distributing hitches apply leverage between the tow vehicle and trailer. This assists in equalizing the weight between vehicles, resulting in both vehicles traveling level. As a reminder, the condition of the tow vehicle's suspension system will affect the towing performance capability of your equipment.



CAUTION

Using an oversized or undersized hitch can cause damage to the frame of your travel trailer or tow vehicle.

Hitch Height Specifications

Due to axles being either straight or drop bars, the ball height will vary. To find the correct height for the ball hitch, set your trailer on a flat surface in level position. Begin measuring from the inside of the ball socket to the ground, approximately 18 to 22 inches, for correct spacing. You may wish to add 1 to 2 inches to this amount to compensate for sagging in the suspension of the tow vehicle when hooked to the tow vehicle.

Hook-Up

Hooking up your travel trailer will become easier with practice. The following procedure will assist you in the process:

1. To raise the tongue of trailer above the hitch ball on hitch, turn the crank on the jack clockwise.
2. Open the coupler latch.
3. Back the tow vehicle into proper position.
4. Turn the crank on the jack counterclockwise to lower the coupler onto the ball hitch.
5. Close the coupler latch after it is completely seated on the hitch ball.
6. Install weight distributing bars (equalizer) when required, as recommended by hitch supplier.
7. Retract the tongue jack to its maximum height.
8. Attach the cable for the breakaway switch to the tow vehicle.
9. Attach safety chains as per your state laws.
10. Plug in your 12-volt, seven-way electrical connector plug from camper to the tow vehicle connector.
11. Inspect and test the following before traveling:

- a. All the lights are working on the outside of the camper.
- b. Stabilizer jacks are fully retracted.
- c. Steps are in the fully retracted position.
- d. The refrigerator door is latched completely.
- e. Loose items are in a secure location.
- f. Test the brakes for operation before entering the roadway.



CAUTION

Trailers with tandem axles need to travel as level as possible, avoiding different weights on each axle plus handling conditions.

The Safety Chain

Safety chain requirements will vary from state to state. The chain supplied with your camper meets the SAE requirements for maximum gross trailer weight.

1. Cross the left chain under the coupler and attach/hook to the right mounting slot on hitch of the tow vehicle.
2. Bring the right chain under the coupler and attach/hook to the left mounting slot on the hitch of the tow vehicle.

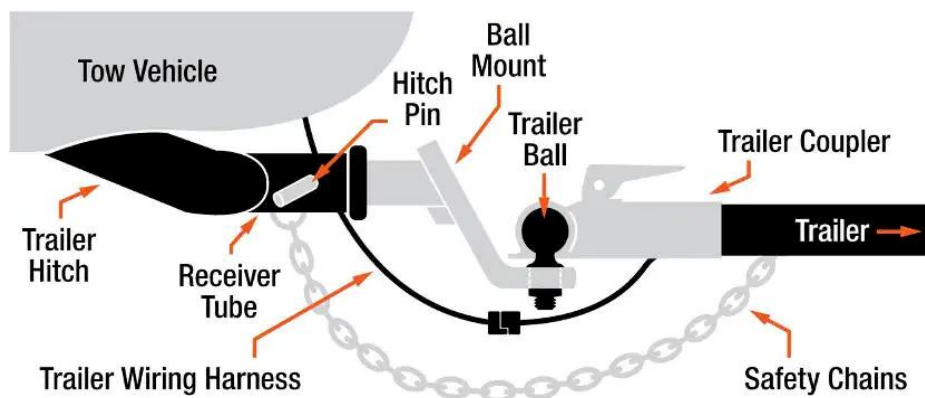

- Remember to leave enough slack in the chains to allow for turning and hold the tongue up.

- Never allow chains to drag on the ground.
- Check chains regularly while traveling.



CAUTION

Remember – always have the safety chain attached to tow vehicle, as required in your state.

Traveling Weights and Loading Information

For safety reasons and federal regulations Bontrager Outdoors RV provides accurate weight specifications to owners. On the exterior left front corner of the camper, you will find three (3) labels.

- 1. Federal Vehicle Identification Number (VIN) label**, as required by the federal government. This tag supplies information concerning your camper such as: VIN number, date/month of manufacture, tire size rating, and weights.

MANUFACTURED BY: Braxton Creek RV, LLC		DATE: 11/6/17	
Shipshewana, IN			
GVWR	3178	KG(7000 LB)
GAWR ALL	1589	KG(3500 LB) PER AXLE WITH
AT	448	KPA(65 PSI) COLD SINGLE
		2040	TIRE
		2205	RIM
THIS VEHICLE CONFORMS TO ALL APPLICABLE US FEDERAL MOTOR VEHICLE SAFETY STANDARDS IN EFFECT ON THE DATE OF MANUFACTURE SHOWN ABOVE.			
VIN:	7HFB1KJ2XJ17A0057	TYPE:	TRAILER
		MODEL:	26 BH
			FD-304 REV A

Gross Axle Weight Rating (GAWR) is the value specified as the load carrying capacity of a single axle system, as measured at the tire-ground interfaces.

Gross Vehicle Weight Rating (GVWR) is the maximum permissible weight of the trailer when fully loaded. It includes all weight at the

trailer axle(s) and tongue. This weight number includes ALL cargo options and liquids.

Unloaded Vehicle Weight (UVW) is the weight of the trailer as manufactured at the factory. It includes all weight at the trailer axle(s) and tongue or pin. If applicable, it also includes full generator fluids, including fuel, engine oil, and coolants.

Cargo Carrying Capacity (CCC) is equal to the GVWR minus each of the following: UVW, full fresh (potable) water weight, including water heater and full propane weight.

2. Recreation Vehicle Trailer Cargo Carrying Capacity label provides the weight of the cargo placed in your camper. It is on the inside of your camper, on the screen door or inside of a cabinet door. It provides the total allowable weight of cargo minus liquids allowed, water and propane.

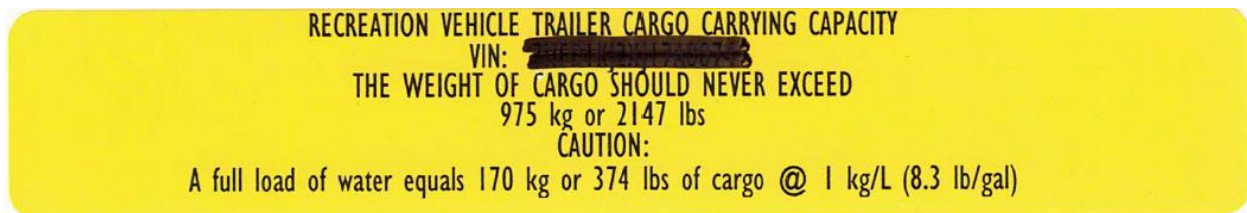

3. Tires and Loading Information

All Bontrager Outdoors RV campers are equipped with appropriate tires for recreational vehicles. Tires are rated to carry weight as listed to the GVWR. Tires are radial in design using components to offer excellent strength and mileage in all kinds of weather conditions.

Tires on your vehicle(s) are one of the most important components of the towing package.

Safety on the roadway is very important. With proper care, the tire performance and fuel economy will be maximized.



TIRE AND LOADING INFORMATION

The weight of cargo should never exceed
975 Kg or 2147 Lbs.

TIRE	SIZE	COLD TIRE PRESSURE	SEE OWNER'S MANUAL FOR ADDITIONAL INFORMATION FD-314
FRONT	ST205/75R14D	65 PSI	
REAR	ST205/75R14D	65 PSI	
SPARE	ST205/75R14D	65 PSI	

1HFB1KJ2XJ17A0054

On this label you will find the Vehicle Identification Number, information regarding the tires, including tire size and amount of air pressure (maximum).

All Federal mandated labels are permanently attached to the trailer on the front corner of exterior and easily readable from the outside of vehicle without moving any covers.

Due to weather elements, labels may fade over time. You may wish to record this information and keep it inside of the camper with the owner's manual.

Weighing Vehicle (Loaded or Unloaded)

The proper method to weigh the camper is to use a truck scale. Place the camper axles (tires) and tongue jack or landing jacks with front supports, 12" to 24" from the edge. Unhook the tow vehicle and move forward 6" to 8", now record total weight. Re-hook the tow vehicle and remove the weight from the front support. Be sure no part of towing vehicle is on the scale. Now record the axle weight only.

The difference between the two weights is the hitch weight. Bontrager Outdoors RV suggests to also weigh each side (2 tires) separately to find balance of pounds per side. It's possible to have one side correct and the other side overloaded. Often the refrigerator side will be slightly heavier than the other.

Loading the Trailer

Your camper has been engineered to make maximum use of the available space for living and storage areas. The equipment and supplies you take along while traveling can be carried safely, provided the additional weight is distributed properly.

Proper weight distribution within your trailer is an important factor in safety and efficiency of your trailer brakes, hitching, and how your tow vehicle will pull the camper. **DO NOT** put excess weight in the rear only. Excessive weight in the rear area tends to develop sway and “fishtailing” of the camper.

Lightweight and bulky items such as paper products, bedding, clothing, etc., should be stored in overhead cabinets and closets. Heavy items such as cooking utensils should be placed in lower cabinets. Canned goods need to be in a pantry, if so equipped, or in lower cabinets. Heavy items should be secured to avoid shifting during travel.

A reasonable principle in loading your camper is for every two pounds of weight loaded in front of the axle, one pound of weight must be loaded behind the axle.

Also remember, improper side-to-side loading affects spring condition. Excess weight behind the axle lightens the hitch weight and will tend to magnify any sway that may occur when passing trucks or when gusty winds are present. Uncalculated weight can and will affect road performance.



CAUTION

DO NOT overload your unit. Please follow the GVWR when loading

Cargo Capacities

Cargo can be added to the camper up to the maximum weight specified on the weight label. The combined weight of the cargo is provided as a single number.

Note: the total weight of a fully loaded vehicle cannot exceed the stated GVWR.

Water and propane also need to be considered if traveling with water in fresh tank and a full LP bottle. The weight of filled propane containers is considered part of the weight of the camper before it is loaded with cargo and is not considered part of the disposable cargo load. Water is a cargo weight and is treated as such. Example: If there is a freshwater storage tank of 10 gallons, this tank when filled would weigh about 80 pounds. If more cargo is being transported, water can be off-loaded to keep the total amount of cargo added to the camper within the limits of the GVWR so as not to overload the camper.

Understanding this flexibility will allow for choices to be made that fit your travel and camping needs. When loading your cargo, be sure it is distributed evenly to prevent overloading front to back and side to side. Heavy items should be placed low and as close to the axle positions as possible. Too many items on one side may overload a tire. The best way to know the actual weight of the camper is to weigh it on a public scale. Talk to your RV dealer to discuss the weighing methods needed to capture the various weights related to the camper. This would include weights for the following: axles, wheels, hitch, or pin and total weight.

Towing

When towing your camper recognize the extra weight behind your vehicle. Below is a list of things to remember while traveling:

1. Slower acceleration will occur with a camper and will require more distance to stop.
2. Wide turns are necessary when turning with a camper in tow.
Remember to use your turn signals for your own safety and the safety of others.
3. In passing or changing lanes, remember you will need a longer

distance to pass.

4. Use your rearview & side mirrors frequently to observe your camper and traffic conditions.
5. When being passed by a large truck or bus, be prepared for displaced air as it may cause the camper to sway.
6. When climbing and descending steep, long grades, use lower gears even before it seems necessary. Use your brakes smoothly and evenly.
7. Remember to drive slowly on wet and icy highways to keep control of your vehicle.

Tire Information

Tire Maintenance

Properly maintained tires improve the steering, stopping, traction, and load carrying capability of your vehicle. **Under inflated tires and overloaded vehicles are a major cause of tire failure.**

Understand Tire Pressure and Load Limits

Tire inflation pressure is the level of air in the tire that provides it with load-carrying capacity and affects the overall performance of the camper. The tire inflation pressure is a number that indicates the amount of air pressure, measured in pounds per square inch (PSI), a tire requires to be properly inflated. You will also find this number on the Tires and Loading Information label expressed in kilopascals (kPa), which is the metric measure used internationally.

Recreational Vehicle manufacturers determine this number based on the campers' design load limit, that is, the greatest amount of weight a camper can safely carry and the camper's tire size. The proper tire pressure for your camper is referred to as the "recommended cold inflation pressure."



CAUTION

It is recommended that the tire pressure be checked at the beginning of each journey, and at least once per week to obtain the maximum life of the tires.

Checking Tire Pressure

It is important to check your campers tire pressure at least once a month for the following reasons:

- Most tires may naturally lose air over time.
- Tires can lose air suddenly if you drive over a pothole or other objects. This can also occur if you strike the curb when parking.
- With radial tires, it is usually not possible to determine under inflation by visual inspection.

For convenience, purchase a tire pressure gauge to keep in your vehicle. Gauges can be purchased at tire dealerships, auto supply stores, and other retail outlets.

The recommended tire inflation pressure that vehicle manufacturers provide reflects the proper PSI when a tire is cold. The term cold does not relate to the outside temperature. Rather, a cold tire is one that has not been driven on for at least three hours. When you drive, your tires get warmer, causing the air pressure within them to increase. To get an accurate tire pressure reading, you must measure tire pressure when tires are cold or compensate for the extra pressure in warm tires.

If you have been driving your vehicle and think that a tire is under inflated, fill it to the recommended cold inflation pressure indicated on your vehicle's tire information placard or certification label. While your tire may still be slightly under inflated due to the extra pounds of pressure in the warm tire, it is safer to drive with air pressure that is slightly lower than the vehicle manufacturer's recommended cold inflation pressure than to drive with a significantly under inflated tire.

Since this is a temporary fix, don't forget to recheck and adjust the tire's pressure when you can obtain a cold reading. It is recommended that the tire pressure be checked at the beginning of each journey, and at least once per week to obtain the maximum life of the tires.

Tire Size

To maintain tire safety, purchase new tires that are the same size as the campers' original tires or another size recommended by the manufacturer. Look at the tire information placards or the sidewall of the tire you are replacing to find this information. If you have any doubt about the correct size to choose, consult with the tire dealer.

Tire Tread

The tire tread provides gripping action and traction that prevents your camper from slipping or sliding, especially when the road is wet or icy. In general, when the tread is worn down to 1/16 of an inch, they are not safe and should be replaced. Tires have built-in treadwear indicators that let you know when it is time for replacements. These indicators are raised sections spaced intermittently in the bottom of the tread grooves. When they appear "even" with the outside of the tread, it is time to replace your tires.

FUN TIP: Place a penny in the tread with President Lincoln's head upside down and facing you. If you can see the top of President Lincoln's head, it is time for new tires.

Tire Balance and Wheel Alignment

Tires are not balanced on your camper, nor is it required. You may choose to balance the tires on your camper, however this will not be covered under warranty. Wheel alignments may be needed periodically due to road hazards, such as potholes. This also is not covered under warranty, due to being an uncontrollable element. Wheel alignments will assist with getting the maximum life from your tires. Alignments require special equipment and should be performed by a qualified technician.

Tire Repair

We recommend you take the wheel to a tire shop in the event of needing repairs.

U.S. DOT Tire Identification Number

This begins with the letters “DOT” and indicates that the tire meets all federal standards. The next two numbers or letters are the plant code where it was manufactured, and the last four numbers represent the week and year the tire was built. For example, the number 3197 means the 31st week of 1997. The other numbers are marketing codes used at the manufacturer’s discretion. This information is used to contact consumers if a tire defect requires a recall.

Maximum Load Rating

This number indicates the maximum load in kilograms and pounds that can be carried by the tire.

Maximum Permissible Inflation Pressure

This number is the greatest amount of air pressure that should ever be put in the tire under normal driving conditions.

Cargo Capacities

Cargo can be added to the camper up to the maximum weight specified on the weight label. The combined weight of the cargo is provided as a single number.

Note: the total weight of a fully loaded vehicle cannot exceed the stated GVWR.

Water and propane also need to be considered if traveling with water in fresh tank and a full LP bottle. The weight of filled propane containers is considered part of the weight of the camper before it is loaded with cargo and is not considered part of the disposable cargo load. Water is a cargo weight and is treated as such. Example: If there is a freshwater storage tank of 10 gallons, this tank when filled would weigh about 80 pounds. If more cargo is being transported, water can be off-loaded to keep the total

amount of cargo added to the camper within the limits of the GVWR so as not to overload the camper.

Understanding this flexibility will allow for choices to be made that fit your travel and camping needs. When loading your cargo, be sure it is distributed evenly to prevent overloading front to back and side to side. Heavy items should be placed low and as close to the axle positions as possible. Too many items on one side may overload a tire. The best way to know the actual weight of the camper is to weigh it on a public scale. Talk to your RV dealer to discuss the weighing methods needed to capture the various weights related to the camper. This would include weights for the following: axles, wheels, hitch, or pin and total weight.

How Overloading Affects Your Camper and Tires

The results of overloading can have serious consequences for passenger safety. Too much weight on your tow vehicle's suspension system can cause spring, shock absorber, or brake failure. Handling or steering problems, irregular tire wear, tire failure or other damage may also occur.



An overloaded vehicle is hard to drive and hard to stop. In cases of serious overloading, brakes can fail completely, particularly on steep hills. The load a tire will carry safely is a combination of the size of tire, its load range, and corresponding inflation pressure. Excessive loads and/or under inflation cause tire overloading and as a result, abnormal tire flexing occurs. This situation can generate an excessive amount of heat within the tire. Excessive heat may lead to tire failure.

It is the air pressure that enables a tire to support the load, so proper inflation is critical. Since campers can be configured and loaded in many ways, air pressures must be determined from actual loads (determined by weighing) and taken from the load and inflation tables provided by the tire manufacturer. These air pressures may differ from those found on the certification label. However, they should never exceed the tire limitation for load or air pressure. If you discover that your tires cannot support the actual weights, the load will need to be lightened.

Tire Speed Rating

Each original tire installed on Bontrager Outdoors campers have a speed rating of 75 MPH or greater. Please note maximum load rating, tire pressure, and speed rating as imprinted on the sidewall of tire.

How to Change a Tire

1. Place blocking under main rail of frame with tongue jack on top of blocking in front of front spring, ALWAYS on main rail.
2. Break the lug nuts loose before raising the camper. DO NOT REMOVE lug nuts.
3. Raise the camper with jack until wheel and tire is off the ground.
4. Place additional blocking under the frame for security support. DO NOT use tongue jack or the stability jacks to lift the camper.
5. Be sure the camper is stable and on solid ground and will not move with wheel and tire off.
6. Remove lug nuts when the tire is off the ground.
7. Install spare tire and wheel on the camper.
8. Reinstall lug nuts and tighten firmly.
9. Lower the camper back to the ground. When the camper is fully on the ground, remove all blocks and jack.
10. Fully tighten and torque lug nuts at 90 to 120 pounds.
11. Return blocks and jack to a secure location either in camper or tow vehicle.
12. Re-torque lug nuts after traveling 100 miles.

Wheel Lugs

When the wheels are installed on your recreational vehicle, the lug nuts must be tightened at 90–120-foot pounds of torque. Powder coat painted wheels may require more torquing attempts due to thickness of paint. You must re-torque the wheel lugs at 50 and 200 miles.

After your first trip, check the wheel lugs periodically for safety. The wheel lugs should then be checked after winter storage, before starting a trip or following extensive braking. The size of bolts or nuts are 13/16-inch standard and 3/4 inch for chrome nut.

Note: Over torquing will damage components, especially if torque wheel lugs go over 150 pounds. Normally the lug nut fails first, however the embossing on the wheel can also be flattened, and then fails to keep wheel tight.

Brakes – Electrical

Electric brakes on your camper are designed to work in conjunction with the hydraulic brakes on your tow vehicle. This means to have the best brake performance on both systems, the camper and the tow vehicle must perform and operate together. Any attempt to use either brake system alone, tow vehicle or trailer will cause accelerated wear and damage. A brake control must be installed in your tow vehicle to activate electric brakes with 12-volt power either manually or by foot brake pedal. The most popular type is an electronic controller, operating completely on electric current.

See operating instructions provided with the controller for adjustment and operation procedures.

Your controller is to be installed below the dashboard of your tow vehicle. Use the foot pedal control for general operation on combined use of both brake systems. Manual control is to be used only in special situations, such as slow movement or icy road conditions. In the open position, electrical current will flow to brake assemblies activating them. Power from the battery is sent to the controller, the “switch” to provide the correct amount of current to brake assemblies on the camper. As you press harder on the brake pedal, more current will flow, applying brakes more, increasing braking capability. The battery in the tow vehicle is your primary power source to operate the brakes in your camper. Keep your battery and charging system in working operation to ensure available energy when required.

Wiring to operate your brakes must be sized in both vehicles, suggesting a minimum of 14-gauge. Your camper has 14-gauge from front end to brakes. Brake assemblies are wired in parallel, never in a series. Being parallel, there will be equal voltage and amperage at each brake assembly for equal braking capability and/or performance.

When applying brakes to stop the camper, begin pressing slowly to avoid quick and sudden stops, or possible “jack-knife” when wet or slippery. Use lower gear ranges to minimize the need for brakes during extended or steep downgrades.

The brakes installed on your camper are self-adjusting. Self-adjusting brake assemblies will correct any looseness and improve operations as they will adjust in forward or backward motion as needed while the camper is being towed.

Breakaway Switch

The breakaway switch is a safety part of your campers’ electric brake system. The very instant a breakaway occurs the pull pin, which is linked to the tow vehicle, is pulled from the switch. The two contacts automatically close to complete the electrical circuit and apply the trailer brakes. This system will apply the brakes of the camper should it become loose or detached from the tow vehicle. A 12-volt battery installed on the camper is required to power the breakaway switch.

Never use this breakaway switch and trailer brake system as a parking brake. Doing so will cause an unnecessary high amp draw on the battery and converter, potentially causing damaged wiring, connectors, and breakaway switch.

CAUTION: Removing plunger with power to brake assembly could result in damage to brakes.

WARNING: Removing plunger while in storage could result in corrosion to unit points.

WARNING: A tag may be attached to a lanyard cable; DO NOT use as a parking brake.

SAFETY BREAK-AWAY SWITCH WILL NOT OPERATE

Unless connected to a power source equivalent to or greater than an auto-motive type 12 volt, 12 amp hour wet-cell battery.

Campsite Setup and Using Your Camper

We recommend that you select a level or nearly level place for camping. There are two reasons to be level. All components in your camper, such as your water drainage system and especially your refrigerator, are designed to operate in a level position. Should a level site not be available, use short 2 x 6-inch blocks of wood to raise the low side wheels to a level position. Before unhooking the camper from the tow vehicle, be sure the jack foot is in place on the tongue jack and block the trailer wheels to keep the camper from moving.

When on a surface other than cement, before lowering the tongue jack onto the ground, you may wish to place a wood block or hard support under the foot of the jack. This will help to prevent the jack from sinking into the dirt.

Unhooking Your Camper

1. Release the weight distributing bars (if used).
2. Release the safety latch on the coupler.
3. Raise the coupler on the A-frame by turning the tongue jack counterclockwise until the ball is free.
4. Disconnect the 7-way wire connector, safety chains, and the breakaway cable.
5. Raise the front jacks until your tow vehicle will clear the camper. Drive tow vehicle away.
6. Now raise/lower front end until camper is level.

7. Lower stabilizer jacks to desired position to stabilize camper.
8. Reverse procedure to hook up camper to your tow vehicle.

Safety Products & Detectors

General Safety Detector Information

Your new camper comes with 2 safety products, Fire Extinguisher, and Propane/Carbon Monoxide Detector. The safety detectors inside your camper will be actuated much sooner than in a residential home, due to less air volume inside the camper.

Each detector has its owner's manual and instruction sheet, providing more information for its use and maintenance. More information is available in the owner's material supplied by the manufacturer of each detector. The lifetime of the detector is 5 years, and needs to be replaced as per manufacturer's instructions, in the user's guide.

Fire Extinguisher

A fire extinguisher is installed in each camper and is located near the entrance door. Be familiar with its location and operating instructions as printed on the extinguisher. Inspect your extinguisher at least two times per year or more as instructed on the extinguisher.

Propane/Carbon Monoxide Detector—COMBO

Any camper which contains a propane fuel system with propane consuming appliances require a propane leak detection device for safety protection. Currently this detector also serves as a carbon monoxide protection device. A converter or auxiliary battery is required to supply 12-volt DC energy to operate the device. There is not a master cut-off switch to disengage detector.

What is Carbon Monoxide?

Carbon Monoxide (CO) is a highly poisonous gas which is released when fuels are burnt. It is invisible, has no smell and is therefore very difficult to detect with the human senses. Under normal conditions, in a room where

fuel burning appliances are well maintained and correctly ventilated, the amount of carbon monoxide released into the room by appliances is not dangerous. These fuels include wood, coal, charcoal, oil, natural gas, gasoline, kerosene, and propane. Such gases can build up in the blood, interfering with the body's ability to supply oxygen to itself.

Because CO is a colorless, odorless, tasteless, and highly poisonous gas that prevents the blood from carrying oxygen to vital organs, CO is 200 times more likely to replace oxygen in the blood.

It can endanger lives even at low levels of concentration.

Dual Sensor Technology

The combination CO/Propane Gas Alarm is an alarm that combines into a single compact system. It is a powerful alarm that detects both Carbon Monoxide (CO) and Liquefied Petroleum Gas/Propane (LPG/LP).

The sensor uses the latest microprocessor technology combined with two electronic self-cleaning sensors that operate independently of each other. The combined unit can detect CO and explosive gases simultaneously.

Simultaneous CO and Gas Alarms

Because the risk of a propane gas explosion is generally a more serious danger, your alarm unit gives the gas alarm a higher priority during simultaneous alarm conditions.

If your unit generates alarms for both Gas and CO at the same time, the propane LED will be a solid red and the alarm will sound. The CO LED will flash **RED** until the CO is ventilated out of the camper, at which time the LED will not be lit up.



WARNING!

LIMITATIONS OF CO AND GAS ALARMS THIS ALARM WILL NOT WORK WITHOUT POWER

Some reasons for no alarm power are; a blown or missing fuse; broken wire; a faulty wire connection or circuit breaker; a discharged battery; cut lead wires, or improper supply (+) or ground (-) connections.

Operation

When the unit is first powered up, the CO sensor requires a 10-minute initial warm-up period to clean the sensor element and achieve stabilization. The LED indicator will flash on and off during the 10-minute warm up period. The unit cannot go into a CO alarm during the warmup period. To test your unit during the warmup period, press the test button. *See Test Procedure in this manual.*

After the warmup period, the power ON indicator should glow continuously. If the ON indicator light does not turn on, see the product manufacturer owner's manual for more information.

Do not attempt to fix it yourself.

Gas Alarm: When you power the alarm, there will be a warmup period of approximately 3-minutes. This unit cannot go into a gas alarm during the warmup period. Once the 3-minute warmup period is over, the alarm can detect explosive gases.

Low Battery State

This alarm will operate normally down to 9 VDC. Once the battery level drops below 9 VDC, the Low Battery State alarm will sound. Charge the camper battery to full capacity. **DO NOT DISCONNECT THE ALARM.**

Visual and Audible Alarm Signals

This CO/Propane Gas Alarm is designed to be easy to operate. The alarm has two indicator lights, **GREEN** AND **RED**, that display for each monitored condition and a matching sound pattern for alarm conditions.

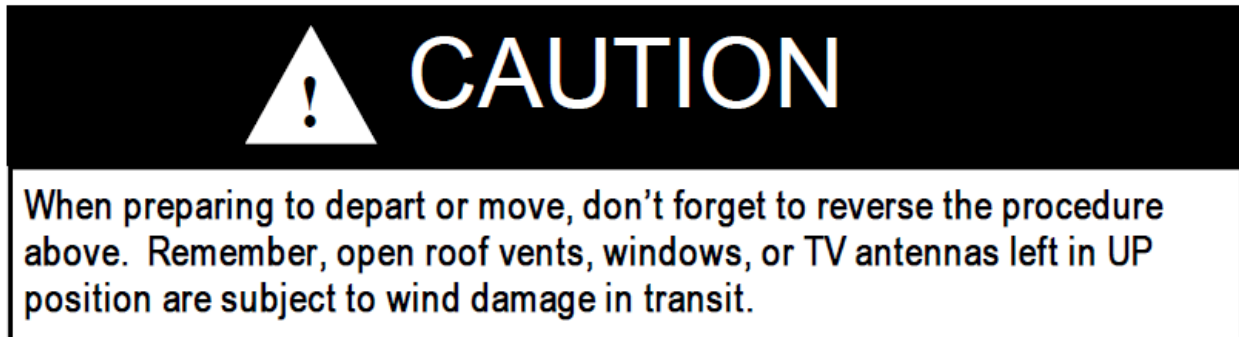

CO Alarm

The **RED** CO LED will flash and the alarm will sound 4 "BEEPS" then be silent for 4 seconds. These signals indicate that the CO level is over 35 ppm. **IMMEDIATE ACTION IS REQUIRED.** See the product manufacturer owner's manual that is supplied with the detector for more information.

This cycle will continue until the TEST/Mute button on the front of alarm is pressed. Ventilate the camper immediately. The **RED** light will stay ON until the CO has cleared or the alarm will reactivate in approximately 5 minutes if the CO is still present. **DO NOT RE-ENTER THE camper.** This alarm will return to normal operation after the camper is properly ventilated.

Propane Gas Alarm

The **RED** LED will stay ON and the alarm will have a constant beep whenever a dangerous level of propane or methane gas is detected. Open all doors and windows, allowing the air in the camper to clear. Contact an RV service center to have your camper checked for any possible propane gas leaks.

OPERATION	AUDIBLE SIGNAL	VISUAL SIGNAL
NORMAL	NONE	STEADY GREEN
CO ALARM	4 BEEPS 4 SECONDS OFF	FLASH RED
PROPANE ALARM ALARM	CONSTANT BEEPS	STEADY RED
END OF LIFE	BEEP EVERY MINUTE	BOTH GREEN AND RED LEDs WILL FLASH EVERY MINUTE

End of Life Signal

All models include an End of Life (EOL) Signal indicating the sensor has reached the end of its service life and you **MUST** replace the alarm. The signal is both **GREEN AND RED** LEDs will flash with a beep every minute. Replace the component immediately. **DO NOT DISCONNECT THE ALARM UNTIL YOU HAVE A REPLACEMENT ALARM READY TO INSTALL.**

Smoke Alarm

Smoke alarms are required when propane is in the camper and open flame cooking happens. The alarm is placed on the ceiling between the sleeping area and cooking area.

Operation

The smoke alarm is in operation once the battery is correctly connected. The LED will flash every minute to show the battery is supplying power to the alarm. When production of combustion is sensed, the unit sounds a loud alarm which continues until the air is cleared.

Testing

Test the alarm by pushing the test button on the smoke alarm cover for at least 3 seconds, until the alarm sounds. The alarm sounds if all electronic circuitry, horn, and battery are working. If no alarm sounds, the unit has a defective battery or other failure and should be replaced immediately.

- Test each smoke alarm weekly to be sure it is installed correctly, and operation is proper.
- Test smoke alarms after the camper has been in storage, before each trip, and at least once a week during use.
- Stand at arm's length from the smoke alarm when testing. The alarm horn is loud to alert you to an emergency. The alarm horn may be harmful to your hearing.
- The test button accurately tests all functions. Never use an open flame from a match or lighter to test this smoke alarm. You may ignite and set fire to the smoke alarm and your camper.

The lifetime of the smoke alarm is 10 years or as stated in the alarm's manual.

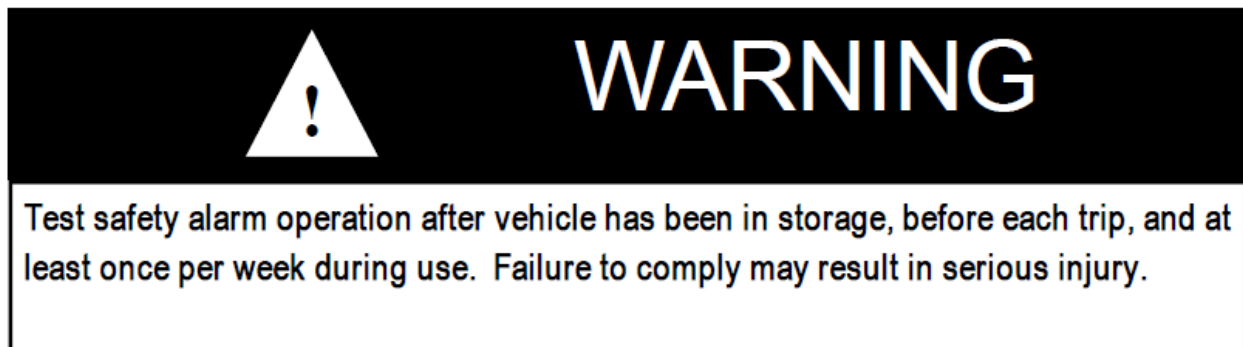

Components On Your Camper

Entry Steps

Before entering your camper, place your hand in the center of the step assembly and pull the step upward and outwards. The step assembly will raise slightly and then out, away from the camper. The arm on the step will meet a positive stop.

Be sure there is antiskid material on each step to prevent anyone from slipping and falling.

Windows

All windows are of slider opening design, solid picture window, or opening vent panels. Sliders may open horizontal or vertical as called for per floor plan. Egress windows have an unlocking handle or two small, hinged clips on each side. After unlatching, the panel will swing out on the top hinge. Some egress windows screens are attached to the swing out panel of window.

Doors and Locks

Locks on entrance doors have two lock mechanisms, a deadbolt in the frame section of lock and a standard lock in the handle. Both locks use the same key. Screen doors may have two types of latches. First, a "roller" latch and secondly, a "hook" latch which needs to be tripped to open. Locks on compartment doors need a small amount of silicone lubricant sprayed internally two times per year to keep functioning correctly.

TV Antennas (Standard Roof Mount)

The TV antenna has a rigid base to mount the receiver head which cannot be rotated or raised up. Inside the camper, on the wall, is a power supply where you hook up to the TV and satellite. There is an ON/OFF button on the power supply to engage the booster, located inside the antenna head. This antenna also serves as a radio receiver for the sound system in the camper. Without 12-volt DC power your signal will NOT be amplified.

CAUTION

The power supply should be turned OFF when connecting/disconnecting cables to power supply and antenna, but should be turned ON when testing for voltage.

Blinds

Blinds with loose cords, such as mini blinds **CANNOT** be installed in bunks. Night shades that are installed have cords anchored to the lower part of the window and need to be secured for operation. Bontrager Outdoors RV recommends these shades be in the UP position for travel to avoid lower metal holder being in contact with garnish on window.

CAUTION: While traveling, all mini blinds need to be in the up position to avoid swinging and scratching paneling. Even with brackets at the lower part of window, pull blinds up before traveling.

Note: *Loose furniture, such as dinette tables, needs to be secured to prevent movement, contacting walls, and causing damage during travel.*

Plumbing System

Water and Sewage Drainage

Your Bontrager Outdoors camper has a complete water system to carry fresh water, as well as holding tanks for wastewater. Below is more information on the fresh and wastewater tanks.

Fresh Water System

Tanks

Water tanks are installed on every camper on the underside of the floor. All water tanks have 3 points of entry or exit.

1. Draw water with pump throughout the camper
2. City Water Fill connection for tank
3. Overflow line attached to fill vent

You have the option to use direct water from your city water hookup or water from your freshwater tank.

S – Siphon hose is used to:

1. Winterize the water system
2. Sanitize water line system

P – 12-volt DC pump to supply camper water when city water is not available

F – Filter Cap needs to be removed and cleaned out or replaced

G – Gravity water fill is used to fill freshwater tank

C – City water fill is used to put water directly into the freshwater lines

V1 – Valve to be open only when using the siphon hose

V2 – Valve to be open only to draw water from freshwater tank. Close this valve when using the siphon hose.

Filling Fresh Water System

To place water into your campers freshwater system, use one of the following methods:

A. City Water Fill, See Figure 1

1. Water is received into the system through a direct hookup, referred to as “city water fill”. Attach a hose to the hook up and supply line. Open the faucet from the supply line. Enter the unit, and open any faucet, to allow air to escape, as there may be some air pockets.

B. Gravity Water Fill, See Figure 2

1. To place water into the freshwater tank, remove cap from fill external connection. Insert the hose into the 1-1/4-inch flex tube 4 to 6 inches. Open the water supply faucet. **DO NOT** overfill the tank as it could burst. *It is not designed to hold pressure.* There is a small screen on the fill, located 1/2 inch at the 10 o'clock position. When water starts to come out **STOP FILLING NOW!**

Figure 1



Figure 2

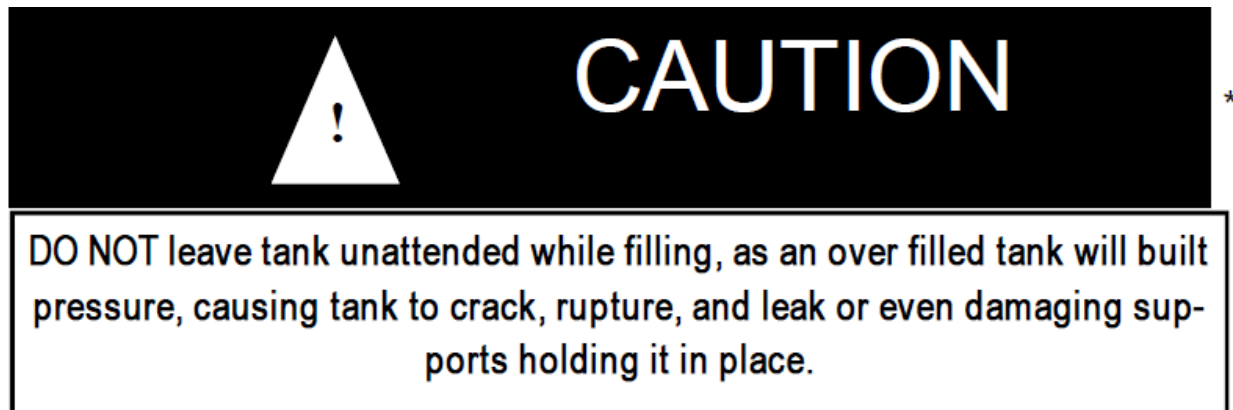

Check the Tank on Monitor panel during the tank being filling process.

A black rectangular warning sign with a white exclamation mark inside a white triangle on the left and the word "CAUTION" in large white capital letters on the right. A small asterisk is located to the right of the word "CAUTION". Below the sign is a white rectangular box with a black border containing the following text:

DO NOT leave tank unattended while filling, as an over filled tank will built pressure, causing tank to crack, rupture, and leak or even damaging supports holding it in place.

12-Volt Demand Pump

When water is desired and you are not hooked up to city water, your freshwater tank will be your water supply. On your monitor panel is a switch to turn on the 12-volt demand pump. The pump will self-prime when started, supply water, and continue to run until approximately 40 pounds of pressure is achieved. When the pressure drops to 20 pounds, the pump will restart. Some cycling in the pump may occur. A check valve is built within the pump to prevent water from flowing into the supply tank. The pump has a small filter attached on the “in port” side to prevent any foreign matter from entering the pump. Removing the lower cup and cleaning it out 1-2 times a year, is recommended.

When the pump is not in use, turn the 12-volt power off at the switch. Occasionally your water pump may start/stop quickly (within a second). This is referred to as “cycling”. There may be a noise that occurs at this time. It may be due to a slightly open faucet, water saver washer at the end of the faucet spout, plus other restrictive issues. If the pump cycles every 10 to 15 minutes, a slight water leak might have occurred somewhere, check valve in city water fill, plumbing fittings, and pressure valve in pump.

DO NOT leave tank unattended while filling, as an over filled tank with built pressure can cause damage to the supports holding it in place, the tank to crack, rupture, and/or leak.

Bath and Shower

Your shower and tub are built of vinyl, ABS or fiberglass material, similar to those in your home.

The shower head used in the bathroom has a non-positive shutoff valve and will drip slightly in shut-off position. A vacuum breaker is also built into the faucet to permit water in hose to drain out as a code requirement.

Before beginning your shower, be sure the water heater is lit and is full of water. *See page 71 for instructions for the water heater.* Adjust the faucet for temperature before entering the tub or shower. After shower use, be sure to turn the water off at the faucet.

Used water will drain through the plumbing pipes into the gray water holding tank. Remember the capacities of your water heater and gray water holding tank. Long showers in a recreational vehicle are NOT suggested due to the amount of water that is available. To conserve water, wet down, and turn water off while you soap up, then rinse. Shower doors are provided with the camper and must be used to prevent water from spilling onto the floor, possibly causing damage.

Outside Shower

A convenient faucet assembly with hot and cold water is available on most units for exterior use washing or rinsing on the outside of camper, such as washing hands and utensils.

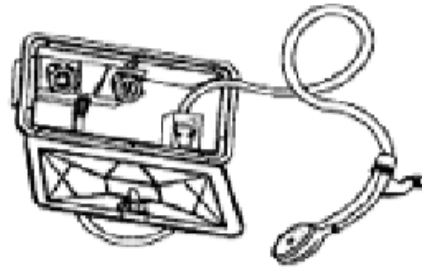

To operate the outside shower:

1. Open the door with key and allow lid to hinge down.
2. Remove the shower head and open valve.
3. Open the faucet valves and adjust to the desired temperature.
4. To end operation close valve(s) on the faucet and allow water to drain from the shower head.
5. Close the valve on the shower head.

Any water remaining in the hose will drip or run out of the vacuum breaker. This is NOT a leak but performs as intended. Water in the ABS plastic box will drain out along outer edge.

The shower head can be removed to drain the hose faster. Reassemble and place onto bracket. Keep the door closed when not in use for sanitary reasons.

Water Lines

Fresh Water Lines

Two lines, generally red for hot and blue for cold, transport water throughout the camper. Valves to direct flow are near the city water fill or pump area. Connector elbows and tees are plastic or copper, and are held together with compression rings for no leakage.

Low-Point Drains

Low-Point drains are placed on campers to drain water lines, tanks, and the water heater to prepare the camper for winterization and sanitizing systems.

Fresh water tanks will have their own separate drains under the frame, with a valve to be opened to drain, an overflow drain line may be close by.

Plumbing lines also have Low-Point drains located in various areas. You may find them (2) for hot and cold coming out of storage areas, outer metal skirt, through under belly covers, control centers, etc. Water should always drain out to the ground, not into underbelly cover.

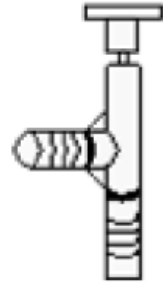

Sanitizing and Draining the Potable Water System

For your safety, you should sanitize your potable water system when your camper is new or when it has been sitting unused for a period of time to prevent contamination.

Prepare a chlorine solution using 1/4 cup of bleach (5% sodium hypochlorite solution) to one gallon of water. Prepare one gallon of this solution for each 15-gallon capacity of the tank. As designed and constructed, this method will sanitize the plumbing system.

1. Close all the drains, tank, water heater and low points.
2. Place prepared sanitizing contents into supply tank.
3. Open faucets and start the pump.
4. Turn the pump on and allow it to run until liquid comes through faucets.
5. Close faucets when air ceases to come out.
6. Allow liquid to remain in the system for 3 hours.
7. Drain and flush with fresh water.
8. To remove any excess chlorine taste or odor, prepare a solution of 1 quart vinegar to 5 gallons of water and allow this solution to agitate in tank for several days by vehicle motion.
9. Drain the tank again and flush with fresh water.
10. Your water system is now ready to use.
11. Turn pump power off when not using it.

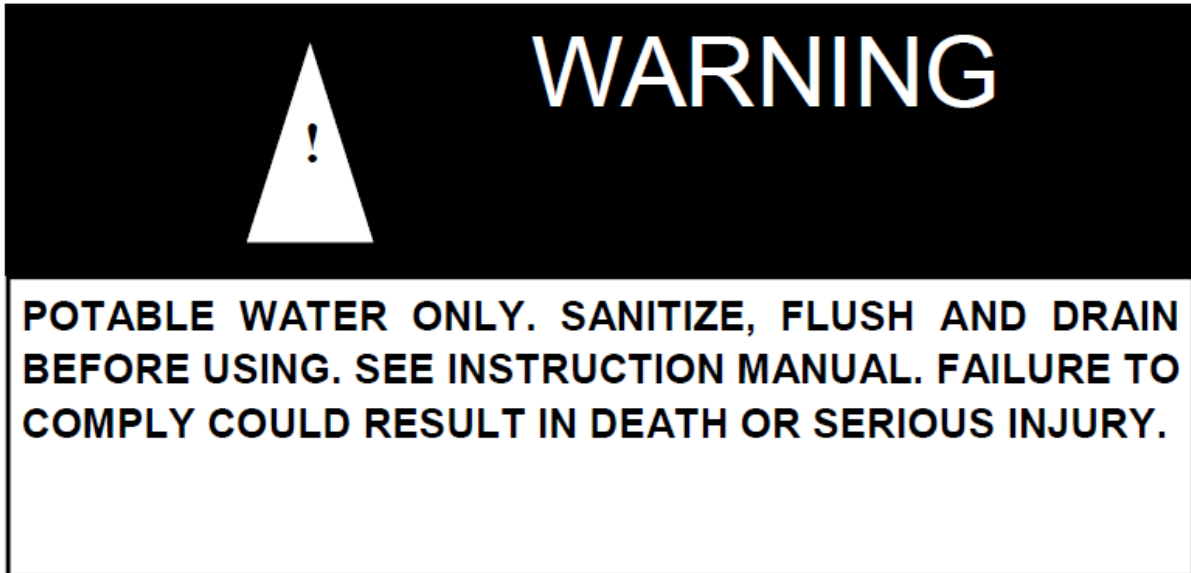

Fresh Water

All permanent freshwater tanks can be drained. Two types of drains are used, (1) a push/pull, (2) a turn valve with open/close position. To drain the supply lines and the entire system, follow the steps listed below. Locate the valve placed at the frame level. These valves will be at the "lowest" point of the water lines.

To Drain System:

1. Open all faucets including optional exterior shower.
2. Open the freshwater tank drain.
3. Open the water heater drain.
4. Open all (two - four) low-point drains.
5. Open the toilet valve, hold or block if need be.
6. To empty the pump, start and allow to run up to 20 seconds.

Sanitation System

Toilets

Prior to using your toilet, be sure to add a proper amount of deodorant chemical into the toilet with water. Flush contents into tank plus two or three gallons of water.

Expect approximately 2 inches of water to remain in the bowl after each flush. This amount is fine for travel. For best operating function, keep 4 to 6 inches of water in the bowl while the unit is stationary. This assists in the flushing procedure. Always flush for 10 seconds or more to ensure all solids and waste move into tank and are not held in drainage pipes.

Using Toilet and Tank System

Unlike your toilet at home which uses 4 to 7 gallons per flush, the average recreational vehicle system uses 2 to 3 quarts. If there is not sufficient water used during flushing, waste materials may not evacuate properly from drain line to tank. Tank and pipes could eventually become clogged.

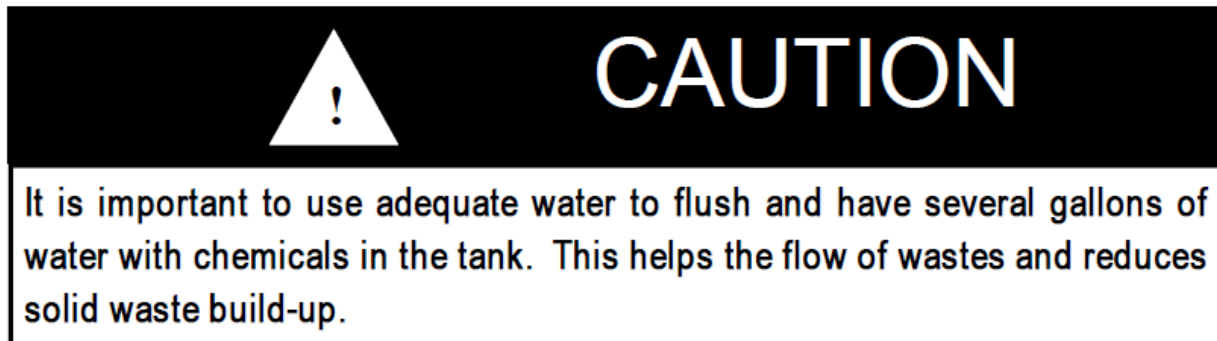

Vent Pipes

A particularly important part of your sanitation system is the vent system in your camper. These vents release air from holding tanks allowing water to enter. Vent pipes are attached to the holding tank, go through the walls and cabinets to the roof. On some models a portion of vent pipe may be part of the drainage system referred to as a "wet vent". As air flows upward, water will be draining downward.

By keeping valves closed in holding tank(s), sewer gases are prevented from escaping through side vent opening. Absence of cabinetry from floor to ceiling is the cause of side vent usage verses roof vent.

Holding Tanks

Holding tanks are parts of your sanitation system that contain waste materials and water. These are located below the frame of your camper.

Gray Tank: Wastewater from the bathtub, shower, and sinks will drain into this tank. No special preparation is required for maintaining the gray tank. However, you may wish to add baking soda or a RV designed chemical to reduce odors from food particles in the system.

Waste Tank: The toilet drains into the waste or “black” holding tank. For correct preparation follow the listed steps:

1. Release 2 quarts of water into the toilet bowl.
2. Place the recommended quantity of chemicals for waste holding tank as per instructions on the bottle into the toilet bowl.
3. Flush liquids into the tank and allow up to 2 gallons of water to flow into the tank.

Each time you drain the tank you should follow the above instructions listed before using.

All drainpipes will have a “P-trap” installed into each line. Water in these traps prevent odors from escaping into the camper. During travel, water from the P-traps may spill and permit odors into the camper. These odors come from fats and food particles decomposing in the tank. By adding water and using an RV approved deodorizing agent, contents will dissolve faster, keeping the drain lines and tanks clean and free flowing. These chemicals are available at most RV supply store.

Draining the Tanks

A final part of your sanitation system is the drainage of holding tanks. Dump station set-ups may vary. Place the camper as level as possible to make drainage easier. Some tanks drain from the center requiring the camper to be level or slightly up in front. Others will drain from the end permitting a slight tilting to the side which drains are on.

Steps for draining the holding tanks

1. Remove the cap and attach the adapter onto the valve housing.
2. Turn the adapter 10° to lock onto the pegs.
3. Attach a flexible sewer hose to the adapter and secure it with a clamp.

4. Place the other end into the approved sewer system.
5. Empty the blank tank first by opening the 3-inch drain valve to drain the sewage tank first.
6. Open the valve on the gray water tank last to utilize water to wash and rinse the hose and drain lines.

Most states and parks have strict laws and regulations to prohibit dumping waste of any kind into anything other than proper disposal facilities or sewer systems. Almost all privately owned parks have either a central pump facility or offer a campsite hook-up for sewage.



CAUTION

Keep drain valve closed. Sewer gases may be present when RV is connected to campground sewage hookup. If drain valve is open, sewer gases may be vented out the side of the RV. (See owners manual).

Winterizing Your Camper

Preparing your camper for cold weather is especially important for most of the United States and Canada. Failure to prepare your camper for cold weather will cause the water systems to freeze, resulting in breakage. Damages related to freezing are not covered under the terms of your limited warranty.

Two methods of winterizing your camper after draining and flushing your drainage system are listed below:

Method 1:

1. Open all faucets, low point drains, and toilet valve to drain all water. Leave these open during this procedure.
2. Start the pump and operate until all water has been removed, this may take about 10-15 seconds.

3. Pour non-toxic RV antifreeze into each P-Trap, remembering to also leave a small amount in the toilet to maintain the air seal.

Follow the directions on your preferred RV approved antifreeze. Each sink has a P-Trap, as does the bathtub or shower.

Method 2:

The water heater bypass kit is designed and built to avoid having antifreeze in the water heater.

1. Be sure to turn off the pump.
2. Drain the water heater and the entire water system.
3. Close the valve on the bottom of the bypass kit to prevent liquid from entering the water heater.
4. Place a siphon hose into container with antifreeze.
5. Open the valve V1 on the siphon hose. Be sure V2 is closed.
6. Turn on the pump to supply the freshwater system with antifreeze. It will take 2 gallons or more, depending on the size of the camper.
7. You may wish to place a container under the faucet to catch excess antifreeze.
8. The closest faucet to the pump will fill first. Turn faucets off as contents emit antifreeze.
9. Take contents in container and pour 1 pint into each drain to protect each P-trap.
10. Any leftover antifreeze in container can be retained for future use.

Bypass Kit

Understanding the valve positions is important. Handles that are in the horizontal position allow water to flow to and from the water heater upon demand. The valve on bottom and top portions of the bypass are choice direction flow valves, not shutoff valves.

When the bottom valve is in vertical position, it will prevent water from flowing into the water heater. The valve on top of the bypass kit, when in vertical position, will not allow back flow into heater. Now you can send antifreeze liquid through the camper plumbing system without filling the water heater. *See page 71 for water heater instructions.*

There are several reasons for not placing antifreeze into heater:

1. Cost. Doing so will take an extra 6-10 gallons of antifreeze.
2. Corrosive. Antifreeze can be corrosive to the anode rod.
3. Residue. It can leave sediment in the tank.

Using the Water System During Freezing Weather

Your camper is not intended to be used during freezing weather unless special precautions are taken. As a reminder, water freezes at 32° Fahrenheit/0° Celsius.

There is no product that can be added to the water to ensure freeze protection when the system is in use, other than RV antifreeze.

DO NOT drink water which contains anti-freeze. (See page 112 for winterizing the water heater)



WARNING

DO NOT use Ethylene Glycol (automotive antifreeze) or Methanol (windshield washer antifreeze) in your fresh water system because they are harmful and may be fatal if swallowed!

Propane Fuel System

The fuel system in your camper has numerous components such as piping, copper tubing, brass connectors, hoses, regulators, and appliances. Each of these components will be explained in its appropriate area.

Propane is the only fuel permitted to be used in a camper and its appliances. This product is refined from crude oil through natural gas. An agent has been added for detection should a leak occur or if a valve should accidentally be left open. It is important for a camper owner to recognize and identify the smell of propane vapor. Other fuels are available but cannot be used in a camper.



Note: *No orifices are available for appliances for either butane or natural gas fuels.*

Propane fuel is stored in liquid form under high pressure in special containers. The boiling point is $-43.6^{\circ}\text{F}/-44^{\circ}\text{C}$, the temperature at which vapor ceases to flow. Fuel will change to vapor when released from the container. Appliances are not designed to operate with liquid. Liquid will damage O-rings in valves and leave a sticky, oily residue resulting in poor or no operation in the regulator.

For every 10° increase in temperature, the pressure of propane in the container rises 1.5%. Example: When a tank is filled at 0°F in the north, travels south to 80°F temperatures, the container will now be filled at 92%, resulting in a potential problem with a 10% valve spewing out propane vapor.

At any point a container is disconnected, BE SURE to install the 'dust cap' over the OPD valve, (if so equipped). Whenever the container is detached from the propane system, DO NOT allow the cylinder to move around or roll around during transportation to and from the gas supplier.

Servicing and Filling Propane Containers

Filling a propane container must be done carefully and correctly. *Only a qualified person, professionally trained in inspection, filling, and safety procedures should fill containers.*

A new container must be “purged” before placing into service and must NEVER BE OVERFILLED. Purging is an operation performed by your dealer or propane agency to remove any atmospheric air. As an owner you need not be concerned regarding this procedure unless you permit the valve to be in the OPEN position when empty. Two overfill devices are built into the valve to prevent overfilling of the container. The first overfill device is the small brass “knob” or “screw” inside of the valve. This “10% valve” must be open when filling, allowing air to escape. When the container reaches 80% of the correct capacity, liquid appears. Shut the supply filling valve off. Close the 10% valve, as well as the top handle of the main valve. Containers with OPD valves have a float on the inside that automatically shut off liquid flow when 80% capacity has been reached.

When refilling propane containers, they are generally removed from propane compartments or tie downs. BE SURE to reinstall correctly, as shown in installation instructions, and test for leaks.

When propane containers are filled to 80% level there is available space for safe expansion of the vaporized liquid. Should your container become slightly overfilled, the hot sun may cause the overflow valve to “blow-off” and emit a small quantity of propane vapor. This can be detected by a strong odor around tanks. **KEEP OPEN FLAMES AWAY FROM THIS AREA.**

Disconnecting Propane Bottle: Turn the acme fitting in a clockwise direction because left-hand threads are utilized. When reconnecting, turn connections counterclockwise. Connections must be tight, however DO NOT over-tighten.

**Propane Tank
Descriptions**

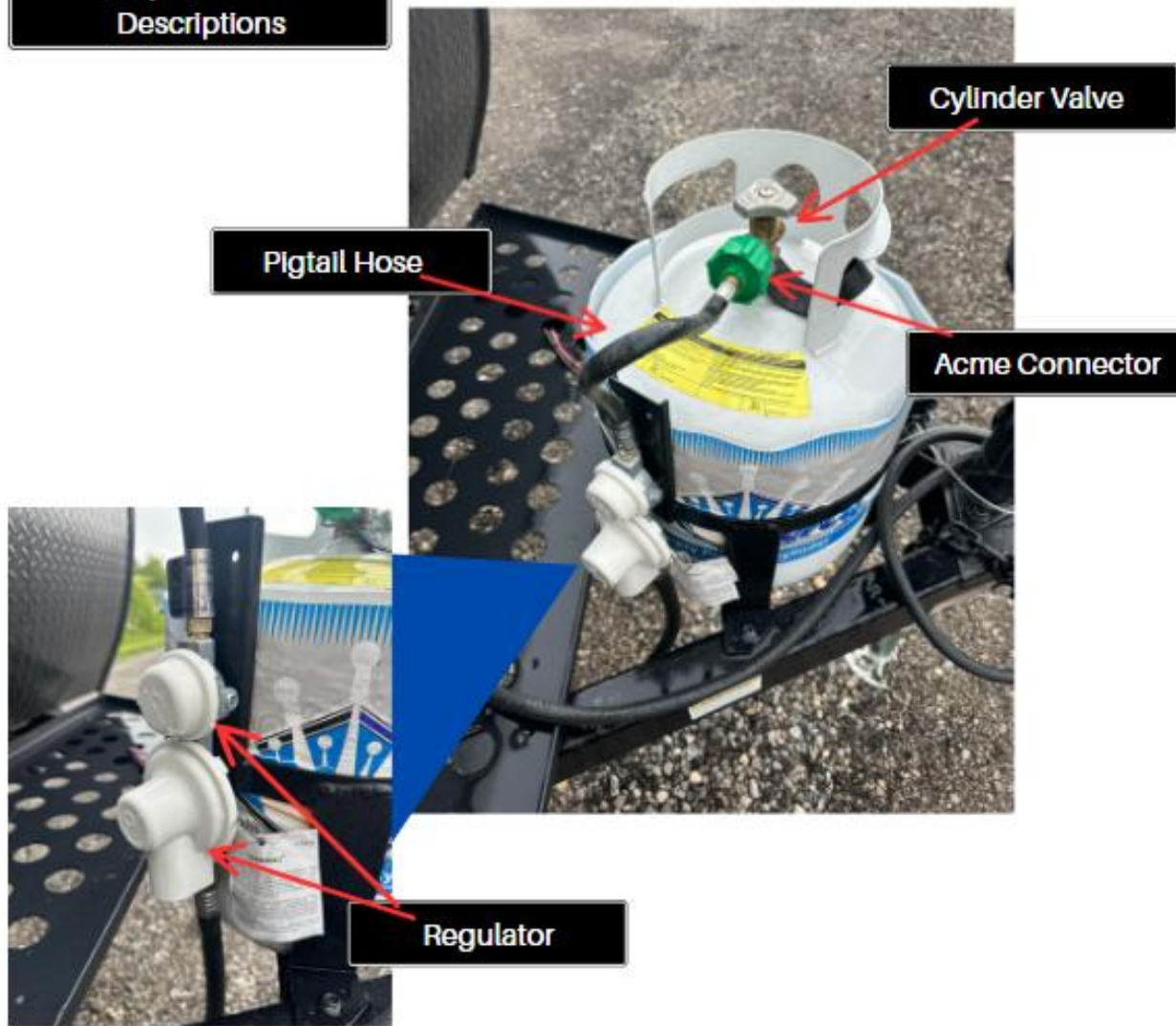

DANGER

All pilot lights, appliances and their igniters (see operating instructions) shall be turn OFF before refueling of motor fuel tanks and/or propane containers.
FAILURE TO COMPLY COULD RESULT IN DEATH OR SERIOUS INJURY.



WARNING

A warning label has been located near the propane container. This label reads as follows:

DO NOT FILL CONTAINER(S) TO MORE THAN 80 PERCENT OF CAPACITY.

1. Overfilling the propane container can result in uncontrolled gas flow, which can cause fire or explosion.
2. A properly filled container will contain approximately 80 percent of its volume as propane.



CAUTION

DO NOT use tools to open or close the tank valve. **HAND TIGHTEN ONLY** to avoid damage to the valve or handle.



DANGER

Never smoke during the filling of propane tanks. Keep the recreational vehicle away from immediate filling area when possible or extinguish all gas pilots.

Propane cylinders shall not be placed or stored inside the vehicle. Propane cylinders are equipped with safety devices that relieve excessive pressure by discharging gas to the atmosphere.
FAILURE TO COMPLY COULD RESULT IN DEATH OR SERIOUS INJURY.

1. Knob to open and close main valve.
2. Complete valve assembly.
3. "10% valve", (small brass knob or slot screw).
4. Container mounting stand.

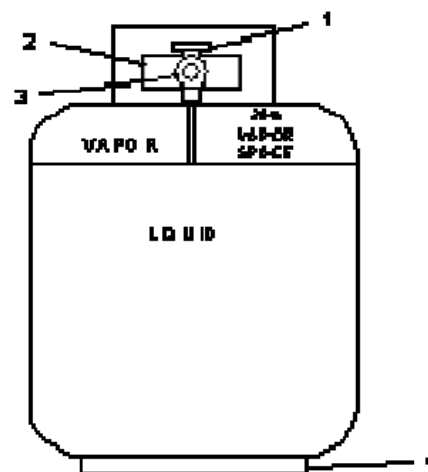

CAUTION

THIS GAS PIPING SYSTEM IS DESIGNED FOR USE WITH PROPANE ONLY. DO NOT CONNECT NATURAL GAS TO THIS SYSTEM.

Securely cap inlet when not connected for use. After turning on gas, except after normal cylinder replacement, test gas piping and connections to appliances for leakage with soapy water or bubble solution. Do not use products that contain ammonia or chlorine.

Regulators

Propane regulators must always be installed with the regulator vent facing downward. Regulators that are not in compartments have been equipped with a protective cover. Make sure that the regulator vent faces downward and that the cover is kept in place to minimize vent blockage that could result in the regulator not operating correctly.

The regulator has the only moving components in the propane system. Its sole function is to reduce the high and varied pressure from the propane containers to safe and consistent low operating pressure. The small inlet is the first stage, which reduces the container pressure to 10-13 pounds.

The second stage then reduces the 10–13-pound pressure to an operating pressure of 11 inches W.C. (water column) or 6.35 ounces of outlet pressure to your appliances.

If pressure is too high, it affects performance and safety. Should pressure be too low, appliances will not operate correctly. An authorized technician with proper equipment should perform such tests and adjustments, as may be required.

Bontrager Outdoors RV uses a standard two stage regulator with a brass T-check connector to mount two propane bottles. We suggest opening only one bottle at a time. Should you open both bottles, they will draw vapor together, resulting in both tanks becoming empty at the same time. This standard regulator is used on smaller campers.

Do not forget to check for leakage each time you refill cylinder or disconnect any part on the propane system.



High Pressure Hoses with Acme Connectors

Propane leaves the container through a hose with an ACME connector attached to the bottle, also having a “flow-limiting device” designed to sense **excessive** flow.

There are two functions of this device:

1. Stops the flow of propane, should the container valve be opened too quickly.
2. Reduces the flow down to Standard Cubic Feet per Hour (SCFH) in case of a rupture in propane line.

Main Supply Hose – Low Pressure

The main supply hose will be attached from the regulator to the brass manifold fitting on the camper's frame. The swivel brass nut on the main hose will be your final attachment.



**3/8" MPT x 1/2" Female
Flare Swivel**

There are several things to remember each time the LP bottle(s) is/are removed:

1. Be sure ALL fittings are tight. Always use two wrenches for brass connections.
2. Be sure ALL connections are tested for leakage.
3. Open the main valve slowly to avoid a fast rush of gas to flow limiting the device causing a gas “freeze-up”.
4. A “hissing” sound longer than one second may indicate a gas leak. Close the valve and search for leak.

Should you experience a propane “freeze-up”, close the main valve and wait 15 minutes before trying again. Keep the container valve(s) closed when traveling. Some states prohibit traveling with the propane container valves open, especially in underground tunnels on expressways.

After the camper is completely set up and you are prepared for

camping enjoyment, follow these steps for propane operation:

1. Be sure ALL burner valves, controls, and pilot light valves are closed.
2. Open the main valve on one propane bottle slowly to avoid a fast rush through excess flow valve causing a “freeze-up”.
3. Listen carefully as propane begins to flow. If a “hissing” sound is heard for more than one or two seconds, close valve and search for a potential leak.
4. Light an appliance to make sure all air is out of the LP lines and the appliance ignites properly.



DANGER

IT IS NOT SAFE TO USE COOKING APPLIANCES FOR COMFORT HEATING. Cooking appliances need fresh air for safe operation.

Before operation:

1. Open overhead vent or turn on exhaust fan.
2. Open window (s).

FAILURE TO COMPLY COULD RESULT IN DEATH OR SERIOUS INJURY.

Unlike homes, the amount of oxygen supply is limited due to the size of the recreational vehicle, and proper ventilation when using the cooking appliances avoids danger of asphyxiation. It is especially important that cooking appliances not be used for comfort heating, as the danger of asphyxiation is greater when the appliance is used for long periods of time.

FAILURE TO COMPLY COULD RESULT IN DEATH OR SERIOUS INJURY.

Checking for Leaks

The entire propane distribution system and all appliances have gone through a complete factory and dealer leak test for any potential leaks.

When traveling with your camper, normal vibrations and road movement may cause connections to loosen and develop leaks.

For normal maintenance we advise all owners to test for leakage at least once per year or more often. You may request your dealer to perform a maintenance check each spring.

Should you encounter an odor, possibly propane, turn off all open flames and begin a systematic search for leaks on the complete propane system. NEVER USE A MATCH. Use a soapy water solution which contains NO AMMONIA or CHLORINE content to check for leaks. If a leak is identified, bubbles will appear. ALWAYS use two wrenches when tightening brass connections to prevent twisting of copper.

For your own protection, the following warning label has been placed near the cooking area to remind you of the need for oxygen for combustion and breathing. Due to the smaller area in your recreational vehicle, there is less oxygen than in your home and proper ventilation is required when cooking.



DANGER

If You Smell Propane:

1. Extinguish any open flames, pilot lights, and all smoking materials.
2. Do not touch electrical switches.
3. Shut off the propane supply at the tank valve(s) or propane supply connection.
4. Open doors and other ventilating openings.
5. Leave area until the odor clears.
6. Have the propane system checked and leakage source corrected before using again.

FAILURE TO COMPLY COULD RESULT IN EXPLOSION RESULTING IN DEATH OR SERIOUS INJURY.



DANGER

Portable fuel-burning equipment, including wood and charcoal grills and stoves, shall not be used inside the recreational vehicle. The use of this equipment inside the recreational vehicle may cause fire or asphyxiation.

It is especially important that cooking appliances **not be used for comfort heating**, as the danger of asphyxiation and unsafe levels of carbon monoxide are greater when the appliance is used for extended periods of time.

Propane Consumption

All your propane appliances are operated intermittently. Your furnace uses the most fuel, especially if freezing conditions are present outside. On a very cold and windy day it is conceivable that your camper could consume most of a 20-pound propane bottle.

Propane consumption depends mostly upon individual use of appliances and the length of time operated. Each gallon of propane produces about 91,500 BTUs of heat energy. The following is a list of typical appliance consumption when turned on fully for one hour of operation:

APPLIANCE	LP GAS CONSUMPTION
Water Heater	12,000 BTU
Furnace	20,000 - 35,000 BTU
Stove	6,500-9,100 BTU

Note: The chart above represents several different models



Electrical System

General Information

The electrical system in your camper is designed for using both 120-volt AC (alternating current) and 12-volt DC (direct current) capabilities. All installations and designs are built to comply with safety requirements of ANSI standard 1192 National Electric Code.

All campers manufactured by Bontrager Outdoors RV have 30-amp.

It is highly recommended that your camper's electrical connection is not plugged into a household outlet.

Changes and Modifications

Any changes, alterations, additions, and/or modifications need to be performed by qualified electrical technicians, using only approved components which meet safety and code requirements. This includes owners, dealers, etc. who desire to make changes. The manufacturer is not responsible for any changes or alterations made to the 120-AC system of the camper.

120-Volt A/C System

Power Cord 30 AMP

The power cord is detachable and must be placed inside of the camper for storage and transportation. To use the power cord, remove from storage and attach the cord to 120-volt power source.

Circuit Breakers and Box

On a 30-amp system, a maximum of six distribution circuits are permitted. All breakers are sized according to the power needs on each line.

The following generic drawing shows the circuit breaker alignment with Number 1 being the main breaker on all floor plans. Depending on the size, floor plan and options of your camper, circuits 3 - 6 will vary and there is a possibility of not all circuits will be used. Number 2 is generally the 20-amp air conditioner circuit.

The camper is equipped with the availability of 30-amp service. Conserving and choosing which appliance has priority in consumption should be considered. *EXAMPLE: Running the A/C and microwave at once may cause a power outage. Consider turning off the A/C to use the microwave, while on 30-amps.*

Loose items such as toasters, electric skillets, and coffee pots also consume power. Include these items also in electrical consumption planning.



DANGER

Do not replace breakers or fuses with any that are rated at a higher amperage. Over fusing may cause a fire by overheating the wire.



WARNING

DO NOT connect 240 volt direct power to the coach through a reducing adapter. By doing so, “positive” power will be sent through neutral/white wire damaging appliances.

GFCI Protection

Each camper has a GFCI (Ground Fault Correction Interrupter) protection receptacle installed into the circuitry. This GFCI device is designed to protect people from hazards of line to ground electric shock. The purpose is to reduce possible injury caused by electrical shock, resulting from faulty insulation, improper polarity and related to moisture and/or earth ground or using the wrong extension cord. The third “round” pin on the receptacle is particularly important for this safety device to function correctly. NEVER cut off this pin. When using an appliance in the receptacle without this provision, use an adapter with a pigtail to be attached to the receptacle box to complete the circuit.



This GFCI receptacle will not protect against short-circuits or overloads. The circuit breaker or fuse in the electrical panel which supplies power to the circuit provides this protection.

During use of the camper, it is suggested to test this receptacle once per month. To test, press the “TEST” button in. The “RESET” button should pop out. The power should now be turned off at this receptacle and any receptacles down line. To restore power, push then release the “RESET” button.



WARNING

Never use a “cheater” plug or extension cord which breaks the continuity of the ground circuit to the grounding pin.



WARNING

NEVER, under any circumstances, remove a grounding pin in any cord or plug. It may mean the difference between LIFE OR DEATH.

12-Volt DC System

Most interior lights and appliances receive 12-volt DC power through the converter output and/or the auxiliary battery. Exterior lights and brakes also use 12-volt DC power from the tow vehicle battery and/or auxiliary battery through the seven-way plug and wiring to the tow vehicle.

Converter

The 12-volt DC system is enclosed inside of the load center, including 12-volt fuse panel, 120-volt breaker panel, and the converter. The fuse panel may have numerous fuse positions depending on the output size of your converter.

This load center will have a front with a small door to access fuses and breakers.

The function of a converter takes 120-volt AC power and converts it into 12-volt DC power as used in your camper. The 12-volt DC supplies power for some appliances and most interior lights. The floor plan and size of camper indicates the output size.

The converter also charges the auxiliary battery(s) when installed on the camper and attached to 120-volt AC power. The third function of a converter is to send 12-volt power to the fuse panel and throughout the camper.

Each converter has a built-in fan which operates through a load sensor control or temperature sensor. As more current is drawn, the fan will speed up or slow down, based on amp draw and/or temperature. If the fan is not running, it may be a result of the converter overheating. Overheating will cause it to cut out or stop running.

Batteries are not standard equipment or offered as an option on units. However, your camper is prewired to use a battery in the absence of shore power. They can be purchased from your dealer or battery store.

A converter will not overcharge a battery unless a battery has a dead cell or the converter has a malfunction. Some converters have full battery charge

shut offs. Other types reduce the rate of charge as battery conditions reach 12.7-volts DC.

Circuit Breakers and Fuses—12 Volt DC

These two items have been installed in your camper to protect circuitry and components:



! WARNING

DO NOT replace circuit breakers or fuses with a higher current rating than those supplied with your coach. Over-fusing can cause a fire hazard by overheating the electrical wiring.

Fuses are placed into the fuse panel with the converter or into a separate panel near the converter with access inside of the camper. Fuses are placed in your electrical system to protect wiring and components when overloads appear, or short circuits occur. Radios, stereos, and possibly other components may have “in-line” fuses attached to their own wire harness. Two 40-amp fuses are placed in the converter to protect the converter should you connect a battery up backwards. Fuses will blow rather than damage your converter.

Circuit breakers are placed at several locations. An automatic reset breaker is placed within 18 inches of the auxiliary battery. The breaker will automatically reset upon “cool down”, normally 60 seconds.

All wiring used in your camper meets correct amp rating correlated with fuses and breakers in respective panels as required by code.

The camper battery is placed in parallel circuitry with the battery on your tow vehicle. Care needs to be exercised not to drain both batteries together. There are two methods of avoiding this condition:

1. Disconnect the tow vehicle when parked and/or using your camper.
2. A battery isolator may be installed in your tow vehicle to prevent power drain from batteries in both vehicles. This device “isolator” has two useful purposes. First, it sends current from the alternator to both batteries simultaneously. Secondly, the isolator prevents draw from the camper through the battery of the tow vehicle, preserving power to start the engine.

Contact your dealer should you desire an isolator for your protection.

7-Way Plug: Exterior Lights and Connector

Power for exterior lights, such as taillights, turn, clearance, and brake lights are supplied by the tow vehicle.

Note: *the diagram below shows the color code and numbers from the 7-way connector and how power is fed to the exterior lights.*

The positive red wire is attached to the battery to transfer power to the camper.

The connector between the camper and the tow vehicle may build up corrosion due to moisture. You may need to clean these terminals occasionally to ensure good electrical contact.

7-Way Connector Wiring/Function Diagram

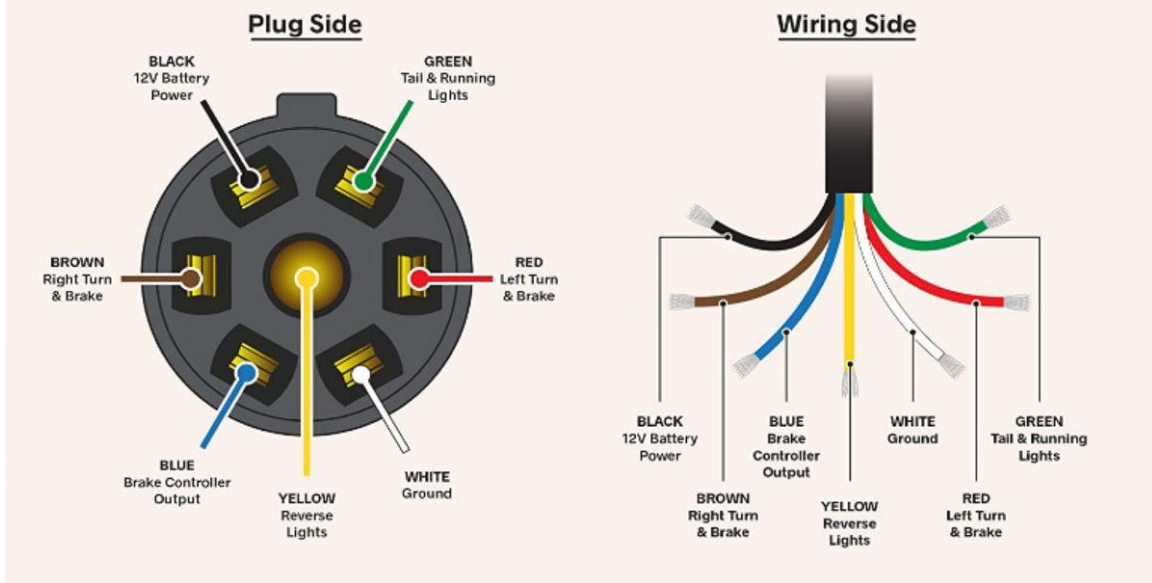

Porch Lights

Porch lights may be placed on sidewalls and the switch will be in the unit's interior on the sidewall.

Brake Wiring

Both 10-inch and 12-inch electric brakes operate on 12-volt power supplied from the tow vehicle, transferred through the blue positive and white negative in the seven-way connector. There are no fuses or breakers installed in this brake wiring. If you are experiencing any electrical problems, check the following items: fuses, breakers, and connections. If none of these items resolve the problem, contact your dealer for trouble shooting and needed repairs.

Solar Panel

Your Bontrager Outdoors camper is equipped with a solar exterior connector. For the installation of solar panels, you must have a solar controller installed by your dealer or solar panel installer. If a solar controller is not installed, any damage to the electrical system or components is not a warrantable issue.

When setting up the solar panel control panel in your camper, you will need to have the battery installed and set the type of battery up in the control panel. Each time the battery is changed, this process will need to be done. See *Solar Panel instructions manual for more information.*

CAUTION

Any electrical installation that does not meet the criteria of the manufacturer's specification will VOID THE WARRANTY on the electrical system.

Appliances

Bontrager Outdoors RV places brand name, quality-built equipment, as guided by current codes and standards, in all campers. Some appliances are built and equipped to operate on propane gas ONLY. DO NOT attempt to operate on natural, butane or methane gas. Each appliance has its own specific manual, written and published by its manufacturer. These manuals supply additional information about the appliances in your vehicle.

The first 3 appliances in this section, all use propane for their MAIN source of fuel, plus some use 12-volt DC and 120-volt AC energy also.

IT IS VERY IMPORTANT THAT AS AN OWNER AND OPERATOR YOU ARE FULLY AWARE WHAT THE SMELL OF PROPANE IS.

The danger information listed below is placed in the manual and a sticker located inside your camper.



DANGER!!!!

IF YOU SMELL PROPANE:

- 1. Extinguish any open flames and pilot lights.**

2. Do NOT touch electrical switches.
3. Shut off propane supply at the container valve.
4. Open doors and windows for ventilation.
5. Leave the area until the odor clears.
6. Evacuate ALL persons from camper.
7. Have the system repaired before using it again.

FAILURE TO COMPLY COULD RESULT IN SERIOUS INJURY, EXPLOSION OR DEATH.

Truma Combi

The Truma Combi is your water heater and furnace. Please refer to the Truma Combi owner's manual for operating and winterizing your Truma Combi.

How to operate the Truma Combi

To wake the Truma Combi system, press the black knob.



To turn on the furnace, turn the knob to the Vehicle icon and it will flash. Press the knob and then choose the temperature you want, then press the knob again.

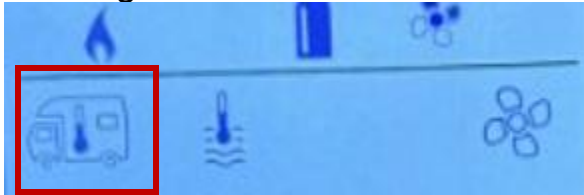

To change the fan speed, turn the knob to the Fan icon and it will flash. Press the knob and then turn the knob to choose the fan speed.



To turn on the water heater, turn the knob to the thermostat icon and it will flash. Press the knob to start the water heater.



To Reset the Truma if you get an Error Code or just the Clock and Wrench icons

Turn the black knob to the Wrench Tool in the bottom right corner and press the knob. *The Wrench Tool will flash indicating you are on it.*



Turn the knob to the right until it says RESET, then press the knob. The next screen will show PR SET, press the knob again and the screen will show INIT..., the system will automatically reset itself.





Dometic Furnace (10HD model only)

The Dometic furnace is for heating your camper. Please refer to the Dometic Furnace Owner's Manual for operation instructions.

Stove Top Burner Operation

Bontrager Outdoors RV uses a drop-in stove in our campers. This appliance operates with propane gas only, NEVER natural gas or butane.

Before attempting to light the stove, BE SURE the valve on your propane container is fully open.





WARNING

Be sure all control knobs are turned “OFF” when you are not cooking. Someone could be burned or a fire could start if a burner is accidentally left on or unattended even if only momentarily.

Operating Instructions:

1. Know which knob controls which burner. Always be sure all burners are turned off when the stove is not in use.
2. Verify sufficient propane supply before attempting to light the burner ports.
3. Depress knob and turn fully counterclockwise to “Light” position.
 - a. Air in the propane line will significantly delay burner ignition.

The burner may light unexpectedly as the air in the lines clear and is replaced with propane. **This unexpected ignition could burn you.** Air in the propane lines may occur after the vehicle propane bottle and/or tank is refilled, during and after servicing other appliances on the same propane line, etc.
 - b. Do not attempt to light more than one burner at a time.
 - c. If the burner should go out while cooking, or if there is an odor of propane, turn the control knob(s) clockwise to “OFF”. Wait five minutes for the propane odor to disappear. If the propane odor is still present **DO NOT** relight the burners. *See instructions in the appliance manual.*
4. To turn the burner(s) off: turn the appropriate control knob clockwise to “OFF”.

Note: *Be sure all control knobs are turned “OFF” when you are not cooking. Someone could be burned, or a fire could start if a burner is accidentally left on or unattended even if only momentarily.*

During the use of your stove, it is important to keep your equipment clean.

If there is an overflow accident, be sure to clean up as quickly as possible. Use warm water with a mild soap to clean grates, cook top, and paint or porcelain surfaces. **DO NOT** use soap which contains ammonia. **DO NOT** use abrasive cleaning pads, steel wool or abrasive soap to clean any

surface because of potential scratching of these items. Should any burner parts or orifice become plugged up, take special care if a brush is used, be sure the bristles do not come loose and lodge in a burner or orifice, causing clogging or a fire. Avoid using a wire brush or wire needles as the ends may break off. Steel items may enlarge the holes causing excess fuel usage, raising BTU's, higher heat, and possibly a fire. Soap and warm water are your best solution.



CAUTION

When the recreational vehicle is not in use or while traveling, it is recommended that the propane supply also be turned off.



CAUTION

Hand held igniters may be used but be sure they are the type designed for lighting open flame burners.



WARNING

When holding the match or lighter to ignite flame, DO NOT position your fingers close to the burner. You could get burned causing injury.



WARNING

DO NOT OPERATE THIS APPLIANCE UNLESS ANY PRIVACY CURTAIN IS SECURED. FAILURE TO COMPLY COULD RESULT IN FIRE OR SERIOUS INJURY.

Refrigerator

Bontrager Outdoors RV campers use refrigerators that operate on 12-volt DC. Performance of refrigerators depends on a range of factors, such as energy, venting, leveling, humidity, and atmospheric heat temperatures, though not limited to these.

For correct operation, the refrigerator **MUST** be level, or within three degrees of the level measurement. Continued operation outside of these limits will result in irreparable damage to the cooling unit in the refrigerator.

Battery Drain Information

To control operating functions on several models of refrigerators, a 12-volt DC power source, battery, and/or converter are required. When your camper is not being used, be sure to turn off any 12-volt items to prevent draining any battery.

Door Seal

To maintain cooling efficiency, the door must seal completely on all four sides along the door gaskets. Frequent frost build-up or reduced cooling are indicators of air leaks around the doors. To test the seal, place a strip of paper the size of a dollar bill between the flange and door gasket. Close the door and pull the paper out. There should be a light frictional drag indicating a proper seal. Should the paper feel loose, the gasket is not sealing well. Contact your dealer or service center.



CAUTION

Do not use undue force or jerking action when opening the refrigerator door. Air temperature differences can cause a partial vacuum within the cabinet requiring a firm but steady force to open the door. A sudden jerk could cause door damage or personal injury.

Operation in Transit

During camping or parking, the refrigerator must be level within 1 degree, for best operation. While traveling, the up and down hill, movement of the camper will not affect the performance of the refrigerator.

Always read the appliance owner's manual from the manufacturer for further operation information.

Cleaning the Refrigerator Interior

Rinsing both compartments in a solution of baking soda and water (one tablespoon of baking soda to one quart of water) will freshen the interior and neutralize odors. Wipe the interior with a soft, dry cloth to prevent water spots. Clean the door gaskets in the same manner as the refrigerator interior. This will help to prolong the life of the gaskets.

Do NOT use abrasive cleaners, they can damage the interior surfaces of the refrigerator.



Always read the appliance owner's manual from the manufacturer for further care and maintenance information.

Operating the Refrigerator Controls 3.3 and 1.7 CU FT

For proper operation and to achieve proper cooling, 12-volt DC power **MUST** be present at the power supply board for it to function. Power comes from a converter, battery, or vehicle battery.

Additional information will be found in the manual supplied by the manufacturer of the refrigerator for all units.

Monitor Panel

Your monitor panel will provide water level information from your water tanks.

Operation requires 12-volt DC power, supplied by the battery or converter. To operate, place a finger on a button and push. A light will illuminate, indicating the water level of each tank.



There is 1 active switch on the monitor panel: the water pump. When in the “ON” position, the pump will run until 40 - 45 PSI is achieved. The pump will shut off and restart at 20 pounds of pressure. Turn pump switch “OFF” when pump is not in use.

When pushing the battery button, the highest light coming on indicates the battery condition:

- C:** Charge at 12.7-volts
- G:** Good at 11.9-volts
- F:** Fair at 11.2-volts
- L:** Low at 6.0-volts

Press only one button at a time, as one set of lights serves all functions.

Maintenance and Care

Your Bontrager Outdoors camper is designed to be as maintenance-free as possible. However, all moveable vehicles require some care to reduce the possibility of unwanted breakdowns during travel. Maintenance of your camper may not seem necessary at the time of purchase, yet it is important to keep your camper in its best condition for your enjoyment. Normal maintenance is required to maintain warranty coverage, reduce wear, and prolong the life of your camper.

Frame

The steel frame on your Bontrager Outdoors camper is cleaned with a high-pressure phosphate spray wash that removes oils, dirt, and residue.

***Note:** It is important to remember that during travel the frame is exposed to stones, sand, road debris, and any other objects found on the road. These items will cause scratching and chipping of the paint, inviting rust to begin from moisture.*

Your frame needs to be inspected and examined every year to touch up or repaint as normal maintenance. We suggest this be performed each fall before storage to guard against winter moisture. The paint to use is a gloss black, in a spray can. You may wish to purchase a commercial rust proof undercoating treatment, such as Ziebart®. However, even such higher priced treatments are subject to road debris and damage.

Coupler

For the ball on your hitch, use a light amount of chassis grease. Lubricate the coupler's pivot points with silicone spray. Avoid grease or oil as they will draw dirt, potentially damaging the coupler.

Jacks

There are many types of jacks used in constructing a camper, such as stabilizer jacks and manual or power tongue jacks. Should any part of these jacks become dirty and rusty, first clean all parts, and then paint as needed to improve appearance. DO NOT paint any moving parts. Tongue jacks, truck camper, and landing gear jacks should be extended to full

length for cleaning. Clean all parts and spray silicone lubricant on the inner tubes. A metal cover is located on the top of the tongue jack and attached with a wire spring clip or a screw. Remove the cover and inspect gears for grease. Regrease if there is no grease present or it has dried out. Only add grease if there is no grease visible. Some jack brands have a hole placed just below these gears to insert oil to lubricate the ram, so it will move smoothly. 10 - 20 drops annually will be sufficient. All jacks listed above have 12-volt DC motors available as a maintenance-free option. Be sure to inspect electrical connections for corrosion and looseness as loose terminals cause excessive heat. All motors are protected by a 30-amp fuse or circuit breaker; located in various places. If replacement is required, only use an equally rated item.

Tires

The tires installed on your camper are matched to the weight of your camper, plus the allowed cargo according to the rating of the tires. It is extremely important to inspect and test the air pressure in the tires no less than once per week, daily during travel. The correct PSI air pressure is listed on each tire as per rating. When air pressure is not maintained as specified on the tires, they may run hot, especially in summer months and blow outs can occur. Tire pressure must always be checked when tires are cold, preferably in the morning. DO NOT adjust or lower tire pressure when warm, as it will be too low when cool. All tire pressures rise when tires are moving on roadway. A tire is considered cold after 3 hours of not moving.



Beginning in the 2017 models, most tires will have nitrogen in them instead of air. A green stem cap will indicate these contents. Air may be mixed with nitrogen with no difficulties.

Tire Repair

If a tire puncture occurs, take it to a fully equipped repair center to ensure correct service. A tire plug or patch inside the well may be necessary.

Wheels

Wheels are manufactured with steel or aluminum material meeting the load rating of the tires. Steel wheels are powder coated paint and should be cleaned and polished yearly to maintain a pleasing appearance. Should you find scratches or chips in the paint, clean and repaint to protect against rust and further damage.

Aluminum wheels require the same cleaning treatment: wash with mild soap and water, no paint. DO NOT use harsh soap or chemicals as they may discolor the wheel's finish.

When changing the tire and wheel, **always** start attaching nuts by hand before using any power wrenches. This will help to avoid cross-threading. Wheel torque is preferred at 95lbs (120lbs maximum). Tighten lugs as listed below. Re-torque wheels at 100 miles and again at 300 miles. Do this each time a wheel is removed and reinstalled. Trim rings and center caps may be plastic or metal. Both require cleaning and polishing, as the plastic will tarnish, and metal will rust if care is not performed.



FASTENER TORQUE WARNING

Improper torque can cause component failure and the axles to become detached from the frame. This could result in property damage, serious personal injury, or loss of life.

Lugs

Check and tighten the wheel lugs regularly. For new campers check and tighten the wheel lugs every 50 miles until 200 miles are reached and then check the lugs every 500 miles.



FASTENER TORQUE WARNING

It is important to maintain proper torque to provide safe and secure attachment of the wheel to the hub/drum. Be sure to use wheel nuts that are compatible with the coin of the wheel. Improperly torqued wheel nuts can cause the wheel to separate from the wheel mounting surface during operation. This could result in property damage, serious injury, or loss of life.

WHEEL LUG NUT DIAGRAMS:

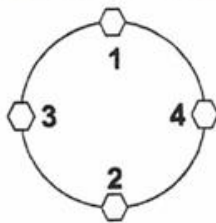

4-Lug Nuts

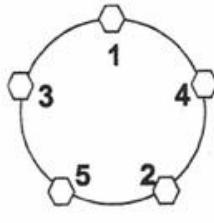

5-Lug Nuts

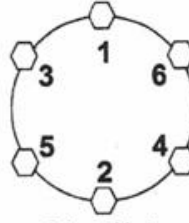

6-Lug Nuts

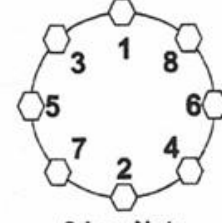

8-Lug Nuts

WHEEL TORQUE INSTRUCTIONS:

1. Start lug nuts with fingers on studs to avoid cross threading.
2. Stage 1, Torque: Impact lug nuts in a star pattern* until snug to rim. -- See *Wheel Lug Nut Diagram*
3. Stage 2, Torque: Use calibrated torque wrench to torque each lug nut, in a star pattern, to the values indicated. Wheels must remain stationary during torquing process for control purposes. --See *Wheel Lug Nut Torque Chart* and *Wheel Lug Nut Diagram*
4. Stage 3, Torque: Use calibrated torque wrench to torque each lug nut, in a star pattern, to the values indicated. Wheels must remain stationary during torquing process for control purposes. --See *Wheel Lug Nut Torque Chart* and *Wheel Lug Nut Diagram*

WHEEL LUG NUT TORQUE CHART:

Lug Nut	Stud Dia.	Rim	Type	Stage 1 Impact Gun	Stage 2 Clicker Setting (+/-3ft/lbs)	Stage 3 Clicker Setting (+/-3ft/lbs)	Acceptable Torque Range
4-Lug Nuts	1/2"	12"	Steel	40-50 ft/lbs	60 ft/lbs	70 ft/lbs	50-75 ft/lbs
5-Lug Nuts	1/2"	13"	Chrm/Steel	40-50 ft/lbs	60 ft/lbs	70 ft/lbs	50-75 ft/lbs
5-Lug Nuts	1/2"	14"	Chrm/Steel/Alum	40-50 ft/lbs	95 ft/lbs	115 ft/lbs	90-120 ft/lbs
5-Lug Nuts	1/2"	15"	Chrm/Steel/Alum	40-50 ft/lbs	95 ft/lbs	115 ft/lbs	90-120 ft/lbs
6-Lug Nuts	1/2"	15"	Chrm/Steel/Alum	40-50 ft/lbs	95 ft/lbs	115 ft/lbs	90-120 ft/lbs
6-Lug Nuts	1/2"	16"	Chrm/Steel	40-50 ft/lbs	95 ft/lbs	115 ft/lbs	90-120 ft/lbs
8-Lug Nuts	1/2"	16"	Steel/Aluminum	40-50 ft/lbs	95 ft/lbs	115 ft/lbs	90-120 ft/lbs

Axles

The axle beam (tube) requires no maintenance unless it has become bent, causing unusual tire wear, camber, or toe in/out. If this occurs, the beam needs to be replaced or realigned to prevent continuous tire wear. Special alignment equipment is required to realign an axle beam to correct this condition. Realignment will require an axle tube to be bent for correct alignment.

***Note:** Paint on axles, springs, etc. has only a primer coat. You may wish to repaint it as part of normal maintenance.*

Bearings

ALL wheel bearings in your camper are pre-greased at the point of assembly. At 12 months or 12,000 miles (about 19312.13 km) of use, inspect the bearings for lubrication and wear.

Repacking Bearings

Before repacking the bearings, take them out of the hub and wash all old grease and grime out with solvent cleaner. You may use compressed air for this process. DO NOT use compressed air to spin bearings during cleanout. It will damage both the casing and the bearings.

Inspect all cleaned parts for wear, pitting, and blue color, indicating heat. If such conditions are found, replace the bearing and cup.

Next, use a high temperature automotive type wheel bearing grease to carefully pack bearings by hand or with a "bearing packer." Grease must be fully forced into ALL cavities between the rollers, cone, and cage of bearings. The soap type should be lithium complex or equivalent. Use NLGI Grade 2 products with a minimum dropping point of 440°F. Always replace bearings and races as a set. Install races with a mild steel drift punch or bar (new hub/drums may have racers already installed).

Do not use hardened steel or brass bars as they may damage, chip, or leave deposits on the races.

The final setting of the race against the shoulder should be checked with feeler gauges and be within 0.002 inches of the shoulder in the hub/drum. After bearings have been packed with grease, place inner bearings into correct position, seated into race or cup. Place a new seal over bearings (NEVER reuse previous seal). Use a seal driver or stiff rubber mallet and tap gently into place. Be sure the seal is seated fully and completely.

To get the proper “feel” for bearing clearance, the spindle nut must turn freely on the spindle and the brake must be readjusted so there is no drag on the drum. While slowly turning the hub/drum, tighten the spindle nut to approximately 20 ft/lbs., then loosen to first notch in nut. This is especially important if new bearing races have been installed. With drum stationary (do not rotate), retighten the spindle nut to 7 ft/lbs. (zero clearance) then back off one slot (0.001”-0.010” end play) and align cotter pin hole. Insert a cotter pin and bend both ends over the end of the spindle. Install the grease cap.

Note: We recommend the repacking of bearings be performed by a certified technician.

 CAUTION
Over packing the hub results in grease seeping out of the dust cap and wheel seal, onto brake pads.
 WARNING
Improper seal or bearing installation or adjustment or insufficient maintenance can lead to wheel bearing failure which could cause the hub/drum and wheel to separate from the axle during operation resulting in property damage, serious personal injury, or loss of life.

 **WARNING**

Improper bearing adjustment can lead to wheel bearing failure which could cause the hub/drum and wheel to separate from the axle during operation. This could result in property damage, serious personal injury, or loss of life.

Brakes

The brakes on your camper are 10"-12" in diameter depending on the weight of the trailer. They function from 12-volt DC power supplied through brake control from your tow vehicle.

 **WARNING**

Improper brake adjustment can result in reduced brake performance or loss of brakes. Reduced brake performance can lead to property damage, serious personal injury, or loss of life.

 **CAUTION**

Always place stationary jack stands or blocks under frame to guard against jack failure.

When a camper's brake system is new, the brake shoes and drum are not completely meshed together. This first adjustment should occur at 200 – 1,000 miles (about 1609.34 km) or when brakes have been engaged 100 times, referred to as "burnishing". After the initial adjustment, brakes should be re-adjusted every 3,000 miles (about 4828.03 km). Under adjustment can cause poor braking and the adjuster wheel to fall apart, resulting in having no brakes and possible damage to other components. Use a qualified technician to perform this maintenance procedure.

To adjust the brakes, follow the following steps:

1. Lift camper. Do not remove the wheels or hub/drum assembly.
2. Locate the adjusting slot at the bottom of the backing plate and remove the protective cover.
3. While spinning the wheel, use a standard brake adjusting tool or the blade of a screwdriver to rotate the star wheel until there is a heavy brake drag.
4. Loosen brake shoes until the wheel turns freely about $\frac{3}{4}$ to 1 full turn.
5. Replace the protective plug to keep dirt and moisture out.
6. Replace all parts and lower camper.
7. Repeat procedure for all other wheels.

Note: *Never adjust just one brake. It is recommended that all brakes on the camper be adjusted at the same time.*

Beginning in 2013 most models have brakes that are self-adjusting.

Brake Shoes

While the hub/drum is removed, the brake shoes also require full inspection for normal wear ($\frac{1}{16}$ " is minimum), cracking from heat (hairline heat fissures are not uncommon in bonded shoes and pose no cause for concern). If there are any questions concerning the severity of cracking, consult with an expert. If the lining is worn to $\frac{1}{16}$ " or less or shows irregular wear and/or contamination from foreign substances, the shoes should be replaced with original parts. If cracking is severe, replace the shoes on both sides—not one side only. Continue to inspect for dirt and other contaminants and ensure the springs are secure and have good tension.

Brake shoes are subject to daily use, absorbing normal wear. Shoes are warranted for workmanship but not for normal wear or failure to maintain.



WARNING

Brake shoes should always be replaced in pairs, both brakes on the same axle. Failure to replace in pairs can result in reduced brake performance or loss of brakes which could result in property damage, serious personal injury, or loss of life.

Brake - Hub/Drum

While the hub/drum is removed for other service work, be sure to inspect the drum for cracks in casting (inside or outside), rough spots (may require sanding), heat distortion (bluish color), out of round drums (high spots), deep scoring of 0.030 inches and over. This requires use of a brake drum micrometer. Resurfacing of the drum may be required or replacement may need to occur.



WARNING

Heavily scored, worn or oversized drums can result in reduced brake performance or loss of brakes. This could result in property damage, serious personal injury, or loss of life.

Exterior Of Camper

Entry Steps

The step assembly is subject to all weather elements and requires the following maintenance:

Covering nicks and scratches

1. Seal any nicks or scratches with an automotive grade primer to prevent rust.

2. Once the nick or scratch has been sealed, cover the damaged area with automotive grade high-gloss paint.

Lubricating the mechanism (every 30 to 60 days)

1. Carefully clean the area around the pivot points (the rivets involved in the motion of the mechanism).
2. After cleaning, lubricate the pivot points (to pinpoint this area, locate the washer between the parts). An automotive grade, non-staining lubricant is recommended. Silicon spray or dry lubricant is suggested, use it monthly during travel use. We suggest lubricating the mechanism once each spring and fall, and once during summer use.



CAUTION

To prevent the possibility of a person slipping on the steps:

1. Lubricate **ONLY** the pivot points
2. Wipe off any excess lubricant and clean the step carefully to be sure no excess lubricant is on the step assembly.

Exterior side walls and roof

Wash the exterior with mild soap and sponge. It is recommended that you do not use a power washer on the exterior of your campers as the power washer could damage the sealant and decals on the exterior of your camper.

Extrusions and Vents

All components installed on the exterior of your camper have some type of “putty tape” placed between the mounting flange or surface to guard against water entry and leakage. Additional sealant, referred to as “cap seal” is used to protect along the edges of extrusions or be a secondary surface sealant. All these sealants are subject to weather elements such as UV rays from the sun, rain, snow, cold, heat, air pollution, frost, and other exposures causing dry-out, shrinkage and possible cracking.

Cap seals MUST be inspected and replaced once a year. We recommend inspecting the seals each spring and fall, for looseness, cracking, and separation from any attached surface. If upon inspection you find the above conditions, remove the old sealant, and reseal the area. These conditions will allow water to enter slowly and eventually cause major damage to your camper. The corner and roof extrusions have putty tape sealant between the components. This material can and will also dry and/or crack from weather elements, permitting leakage and eventually major deterioration. Bontrager Outdoors advises the owner to remove these extrusions, clean out old putty tape, and replace with new putty tape sealant material every two (2) years. Windows, entrance doors, and cargo doors use a black closed cell foam tape for sealant needs, plus an inside butyl tape. These sealants may also deteriorate over time, lose their sealing capability, and shrink with weather conditions, etc. over two years.

Suggested Sealants

Extrusions: Putty tape with butyl content.

Doors & Windows: Putty tape with butyl content or closed cell foam tape with butyl liner on inside.

Cap Seal: This sealant must have good adhesive qualities along with expansion and contraction capabilities.

Systems

Propane System

Your gas line system needs to be inspected for leakage at least once per year, preferably in the spring before you begin your camping season. You may also use soapy water that does not contain chlorine or ammonia, applied on the brass fittings looking for bubbles indicating leakage. If a leak is found, repairs MUST be made before using your camper for safety reasons. This system includes all copper lines, brass fittings to each appliance, hoses, regulator, and steel manifold lines with attached brass fittings. As a manufacturer we suggest you have your selling dealer's service center perform this test unless you have the proper equipment and full understanding of how to perform this test. You may also wish to use a local reputable RV service center to perform this function, such as a "spring maintenance" special at a dealership.

Note: Use “pipe dope” on steel thread -on pipes. Use “Teflon” tape on brass treads and fittings.

Plumbing System

Maintenance to plumbing system is minor, however, there are several items of importance.

Searching for a leak:

1. Place water into freshwater tank.
2. Fill the system with water.
3. Start the 12-volt water pump to full pressure until the pump shuts off.
4. If the pump cycles within 5 - 10 minutes, search for a water leak.

Elbow and tee connections may be found under cabinets, behind cabinets, or under faucets. Many faucets have “water saver” restriction washers in the spouts reducing flow.

Common toilet issues/causes:

1. Valve may be leaking
2. Gasket at bottom of bowl may be allowing water to drain into tank
3. Smell. Deodorizing is needed occasionally to guard against offensive odors from the holding tank.

When cleaning your toilet, a non-abrasive cleaner is suggested with a soft bristle brush. DO NOT use any scouring powders, acids, or concentrated cleaners. These can damage the surface of your toilet.

Holding Tank Maintenance

The following maintenance is recommended by our holding tank suppliers to keep your tanks clean and keep the probes free of debris and build-up.

Gray (Wastewater) Tank - Fill tank with 8-10 gallons of warm water. Add a degreaser such as a citrus cleaner or Dawn dish soap. Leave solution in tank while you are traveling. Rinse and drain tank.

Black (Sewer) Tank - Fill tank with 8-10 gallons of water. Add one bottle of drain cleaner, such as Drano or Liquid Plumber. Leave the solution in tank while traveling. Rinse and drain tank.

Electrical System

120-volt AC testing: Turn off all breakers, plug camper into 120-volt AC shore power, turn on 30- or 50-amp main breaker and then each breaker following. This procedure indicates your 120V system is working correctly and feeding power throughout your camper unless there is an open circuit somewhere.

12-Volt DC

As a manufacturer, we suggest inspecting for any loose wires and/or loose connections in the load center each spring. Tighten them if any are loose. Loose wire connections cause high heat and potential fire issues/concerns, especially in and around circuit boxes.

Inspect all fuses and be sure they are good for continuity and operation. There are 2 - 40-amp fuses or 4 - 20-amp fuses in the converter to protect it, should the battery be hooked up backwards. Be sure these are all in good condition and are not blown.

Use a torque wrench with ¼ inch socket for testing torque tightness on screws holding wire connectors and terminals.

Battery

The battery is not OEM supplied. Your dealership can recommend a proper battery and instruct you on proper maintenance for your camper battery.

Optional Awning

Electronic awning

When using the awning and high winds or heavy rains occur, the awning must be closed into the travel position. Any damage that occurs from high winds or heavy rain is not a warrantable item and will not be covered under the Bontrager 1-year limited warranty.

Manual Override

1. In case of motor issues, the GG750 has a manual override to close the awning.
2. Remove the endcap opposite the motor, by removing the 3 Philips head screws.
3. Using a 13mm wrench, turn the manual override shaft in order to close the awning, see Figure 10. NOTE: The manual override is one-way, it can only close the awning.
4. Figure 10 is showing a right hand motor version of the GG750. If you have a left hand version, the manual override will be on the opposite side.

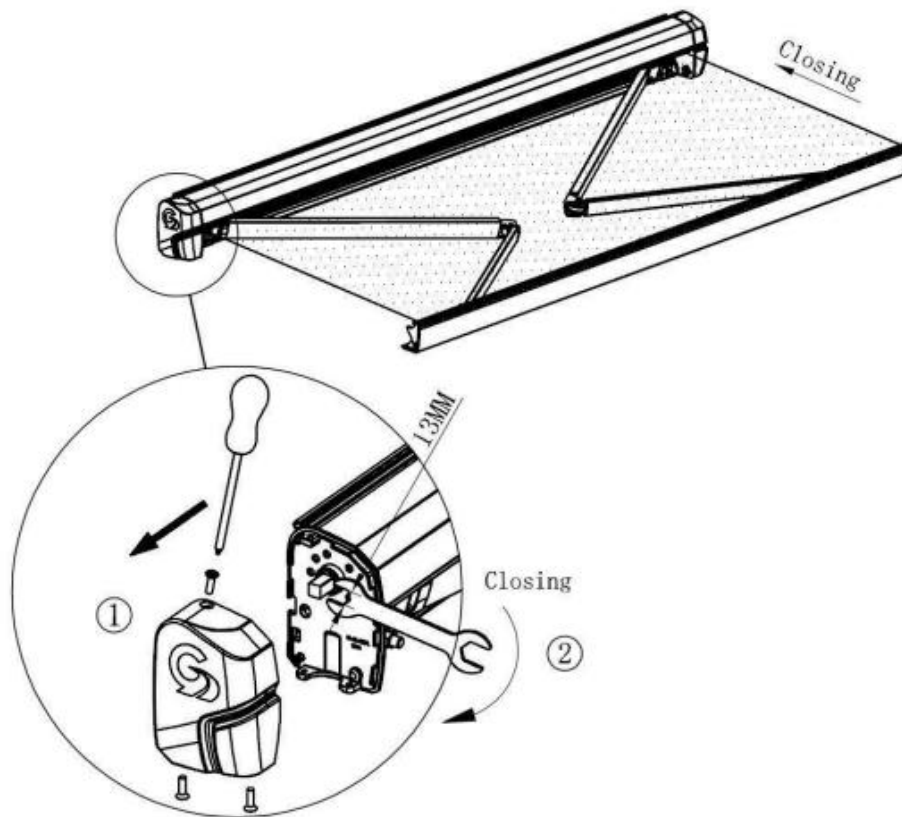

Maintenance Schedule

3 months

- Lubricate entry steps

6 months

- Inspection and reseal any voids in exterior sealant
- Inspect water heater and furnace chambers for insects, webs or obstructions
- Inspect jacks, clean all parts and spray silicone lubricant on the inner tubes.

Yearly

- Remove and reseal all exterior attachments and trims
- Inspect water heater and furnace chambers for insects, webs or obstructions
- Check LP system for leaks
- Inspect wiring for loose connections or any wires that have frayed, contact your dealer to make an appointment to have the wiring repaired
- At 12 months or 12,000 miles (about 19312.13 km) of use, inspect the bearings for lubrication and wear.
- Check plumbing for water leaks
- Wipe down and clean door gaskets on the refrigerator
- Inspect your propane consuming appliances for correct operation. Test all fittings for any possible propane leaks

Thank you for choosing a Bontrager Outdoors unit! We hope you have a wonderful camping experience. Enjoy and be safe out there!

